



Nobelstraat 43
3846 CE Harderwijk
The Netherlands

Phone: +31 341 - 436700
Fax: +31 341 - 436701
www.qimarox.com
info@qimarox.com

Document name: Electrical drawings PRmk1 v6.8
Mounting group: Prorunner mk1
Type: Standard

Power supply: See specification sheet
Control voltage: 24VDC
According to: NEN-EN-IEC 60204-1: 2018

Version number: v6.8

Table of contents

Mounting group		Mounting location		Page	Page description
=A	Prorunner mk1			1	Title page
				2	Table of contents
				10	Layout column
				11	Layout carrier
				12	Layout conveyor on carrier
				20	Overview passive plug-in terminal column
				2000	Parts list
				2001	Parts list
+01		Detection column		500	Field components
+01		Detection column		501	Field components
+02		Gearmotor column		150	Gearmotor, 3 fase
+03		Detection conveyor on carrier		501	Field components
+04		Drive conveyor on carrier		100	Rollerdrive, 24VDC
+04		Drive conveyor on carrier		125	Drummotor, 3 fase

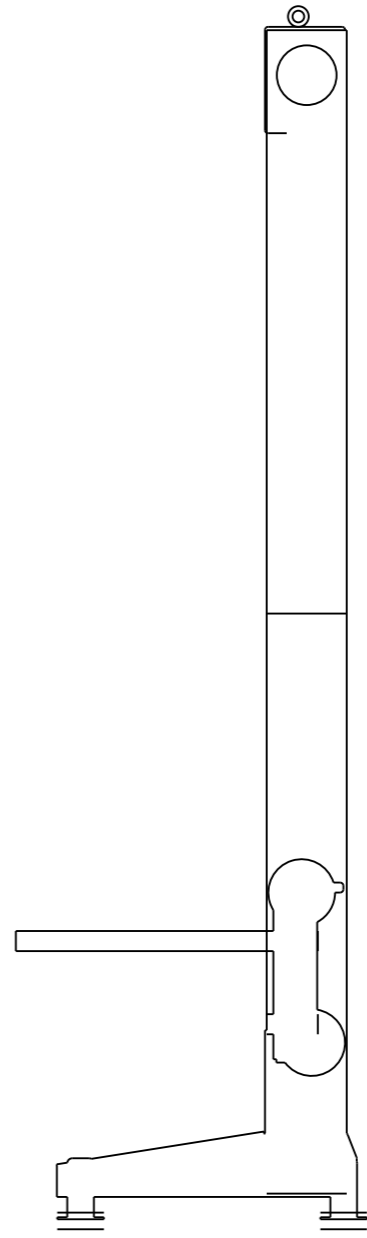
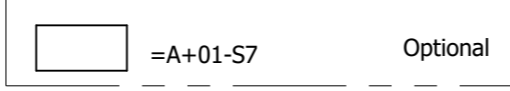
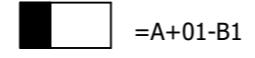
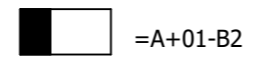
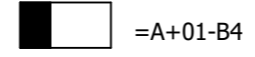
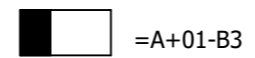
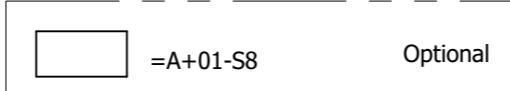
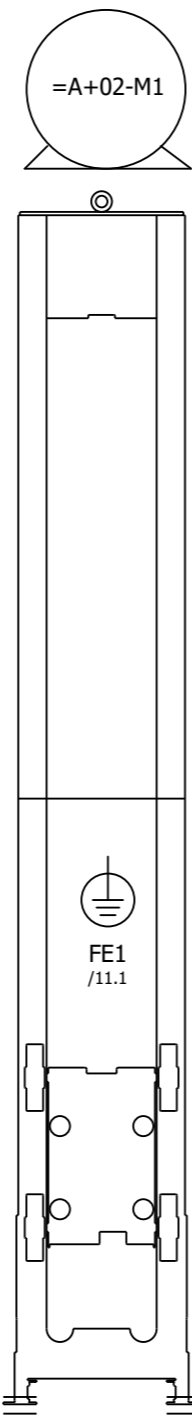
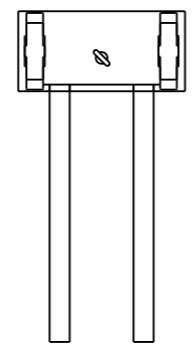

Legend:

- =A+-FE1 Functional ground cable Prorunner mk1 frame to carrier
- =A+02-M1 Gearmotor Prorunner mk1
- =A+01-B1 Bottom stop position
- =A+01-B2 Bottom low speed position
- =A+01-B3 Top stop position
- =A+01-B4 Top low speed position
- =A+01-S7 Bottom limit switch
- =A+01-S8 Top limit switch
- =A+01-U0 Passive plug-in terminal Prorunner mk1

For technical specifications of gearmotor, applied options, machine configuration and other data see specification sheet.

Image may differ from reality.

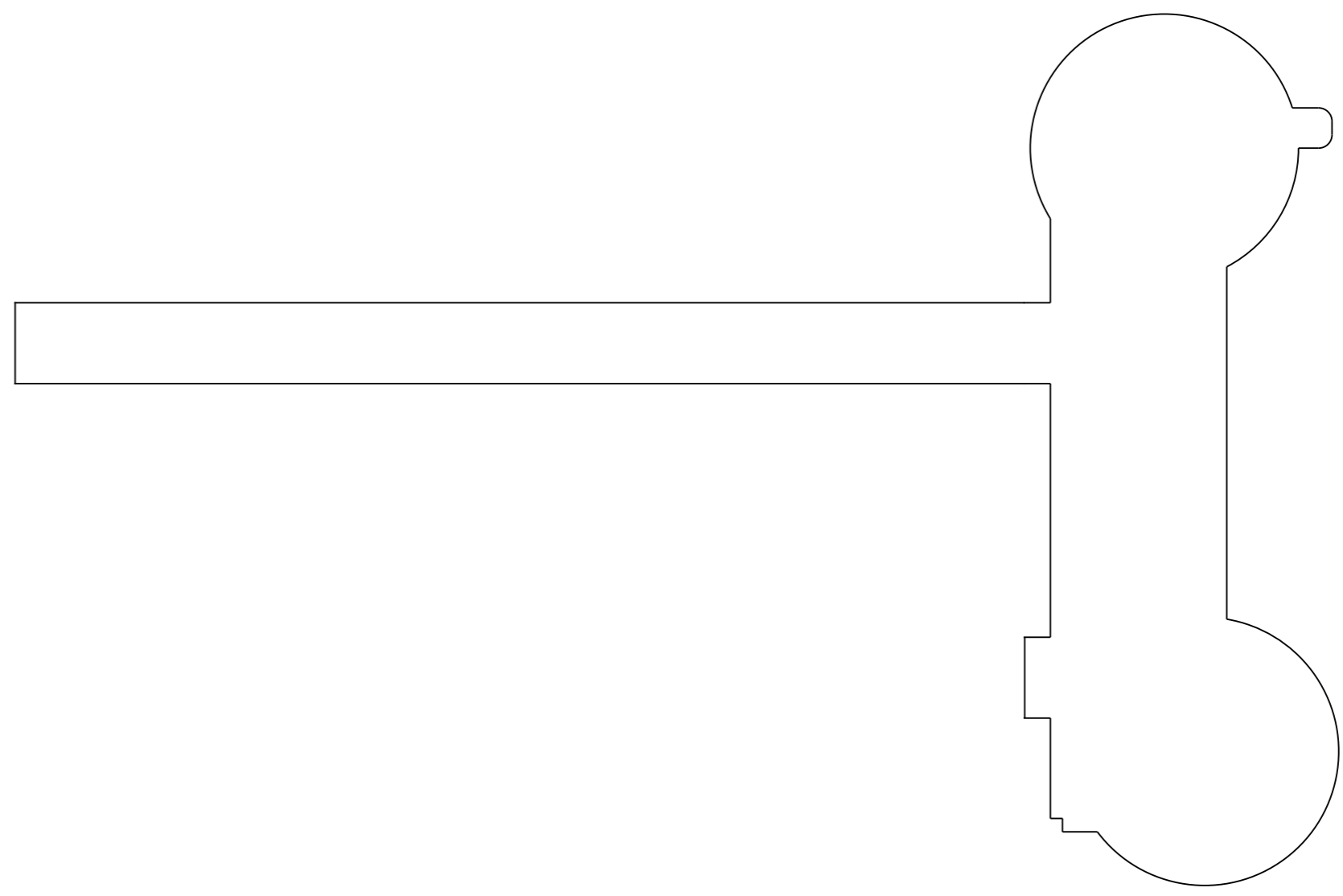
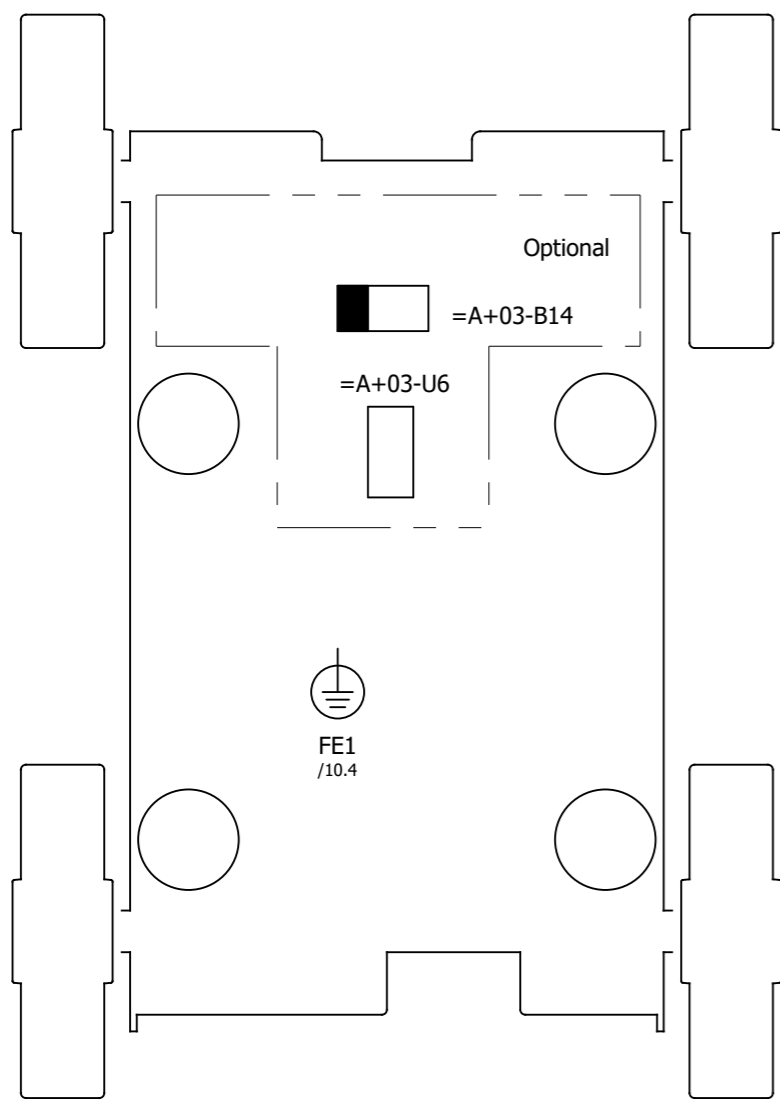

Legend:

=A+-FE1 Functional ground cable Prorunner mk1 frame to carrier

=A+03-B14 Belt slack detection ok Optional

=A+03-U6 T-coupler 2 carrier

For technical specifications of gearmotor, applied options, machine configuration and other data see specification sheet.

Image may differ from reality.

Front in- and outfeed

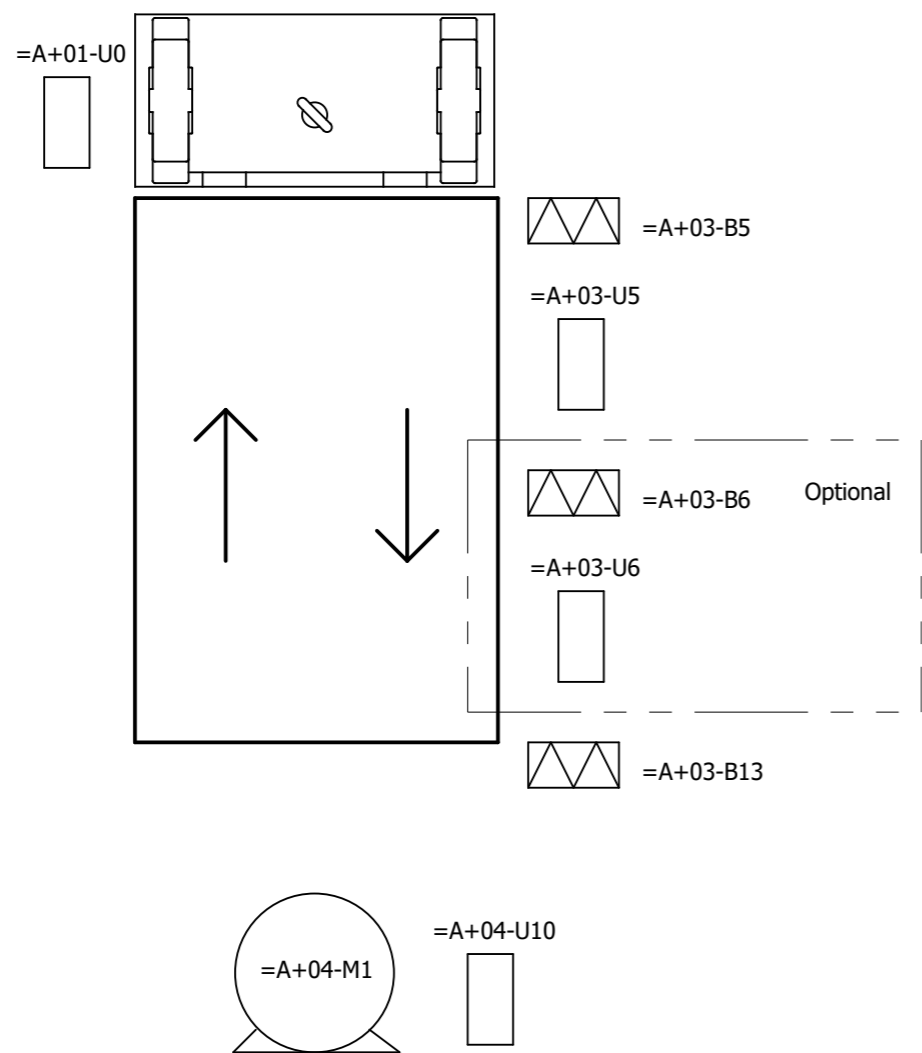

Side in- and outfeed

Optional

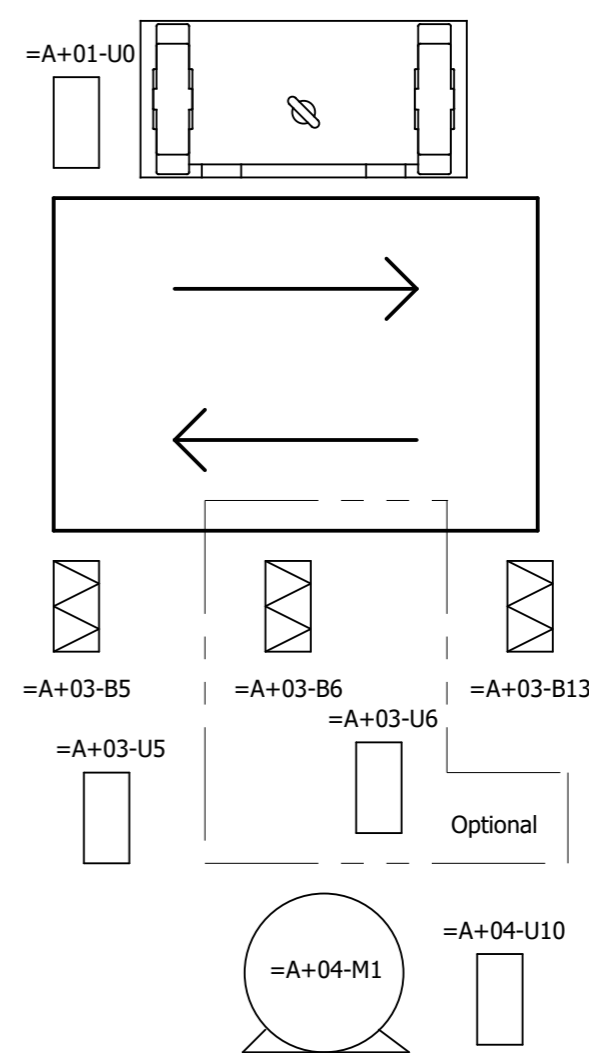

Legend:

=A+04-M1 Drive conveyor on carrier
 =A+04-U10 Drive control, conveyor on carrier

=A+03-B5 Detection carrier not free 1
 =A+03-B13 Detection carrier not free 2

=A+03-B6 Product on conveyor Optional

=A+01-U0 Passive plug-in terminal Prorunner mk1
 =A+03-U5 T-coupler 1 carrier

=A+03-U6 T-coupler 2 carrier Optional

For technical specifications of gearmotor, applied options, machine configuration and other data see specification sheet.

Image may differ from reality.

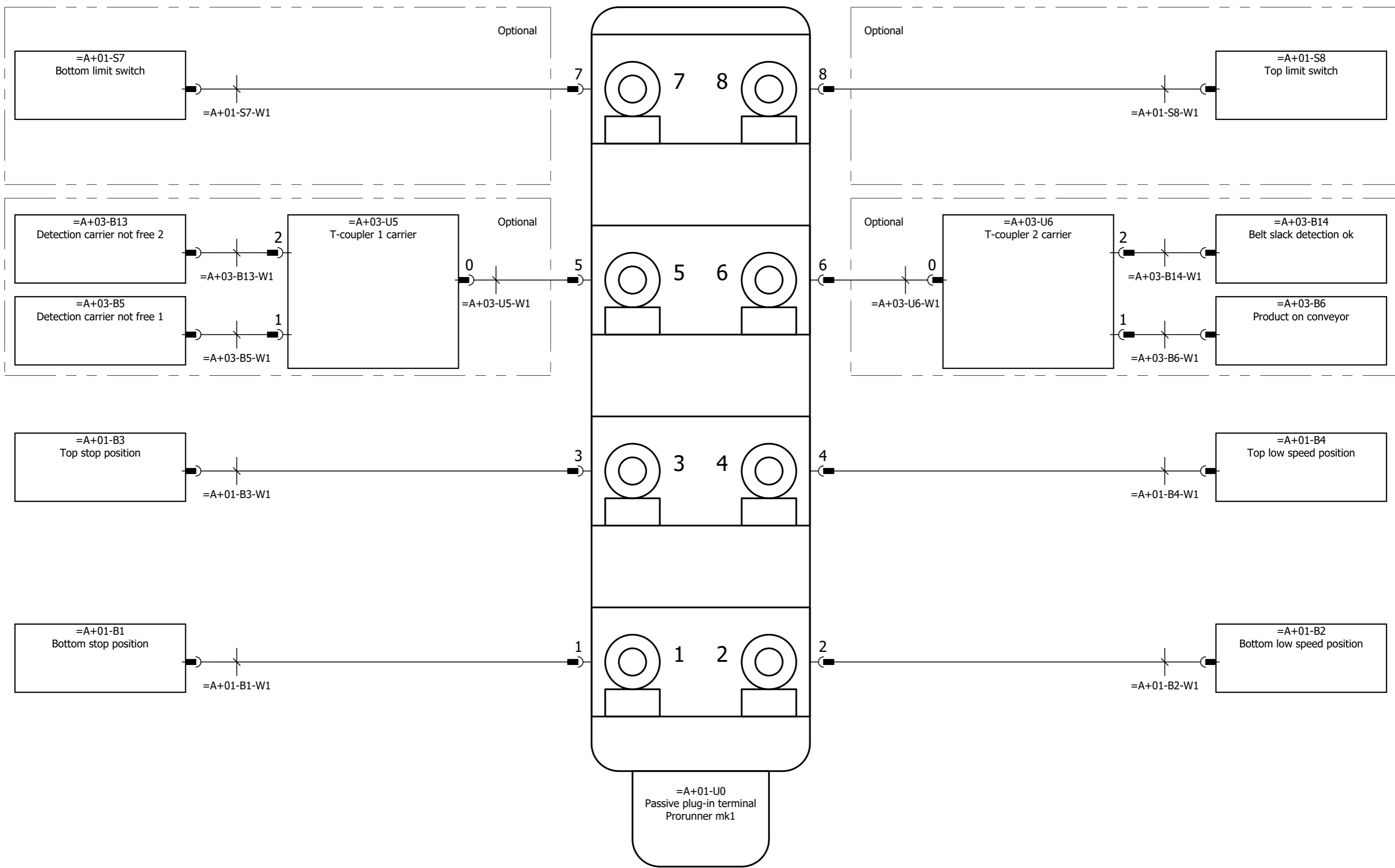

For technical specifications of gearmotor, applied options, machine configuration and other data see specification sheet.

Parts list

Position	Quantity	Article number	Description	Manufacturer	Type number
-FE1	2	1007964	Cable lug, 16mm2, stud M8	Klauke	3R8
-FE1	1	AE0023939	Ground cable 10mm2	Erico	RTCB15-10
+01-B1	1	1000932	Inductive proximity sensor	Sick	IME18-08BPSZC0K
+01-B1-W1	1	1001326	Prefab cable, PVC, 5 meter, connector M12 male 90°+ M12 female 90°, 4-pole	Murrelektronik	PVC-OB 4x0,34mm2
+01-B1-W1	1	1001600	Prefab cable, PVC, 10 meter, connector M12 male 90°+ M12 female 90°, 4-pole	Murrelektronik	PVC-OB 4x0,34mm2
+01-B1-W1	1	1006487	Prefab cable, PVC, 15 meter, connector M12 male 90°+ M12 female 90°, 4-pole	Murrelektronik	PVC-OB 4x0,34mm2
+01-B2	1	1000932	Inductive proximity sensor	Sick	IME18-08BPSZC0K
+01-B2-W1	1	1001326	Prefab cable, PVC, 5 meter, connector M12 male 90°+ M12 female 90°, 4-pole	Murrelektronik	PVC-OB 4x0,34mm2
+01-B2-W1	1	1001600	Prefab cable, PVC, 10 meter, connector M12 male 90°+ M12 female 90°, 4-pole	Murrelektronik	PVC-OB 4x0,34mm2
+01-B2-W1	1	1006487	Prefab cable, PVC, 15 meter, connector M12 male 90°+ M12 female 90°, 4-pole	Murrelektronik	PVC-OB 4x0,34mm2
+01-B3	1	1000932	Inductive proximity sensor	Sick	IME18-08BPSZC0K
+01-B3-W1	1	1001528	Prefab cable, PVC, 2 meter, connector M12 male 90°+ M12 female 90°, 4-pole	Murrelektronik	PVC-OB 4x0,34mm2
+01-B3-W1	1	1001326	Prefab cable, PVC, 5 meter, connector M12 male 90°+ M12 female 90°, 4-pole	Murrelektronik	PVC-OB 4x0,34mm2
+01-B4	1	1000932	Inductive proximity sensor	Sick	IME18-08BPSZC0K
+01-B4-W1	1	1001528	Prefab cable, PVC, 2 meter, connector M12 male 90°+ M12 female 90°, 4-pole	Murrelektronik	PVC-OB 4x0,34mm2
+01-B4-W1	1	1001326	Prefab cable, PVC, 5 meter, connector M12 male 90°+ M12 female 90°, 4-pole	Murrelektronik	PVC-OB 4x0,34mm2
+01-S7	1	AE0005524	Limit switch basic contact element, M12 connector	Schneider Electric	ZCMD21C12
+01-S7	1	AE0005537	Limit switch lever	Schneider Electric	ZCY54
+01-S7	1	AE0005534	Limit switch control head	Schneider Electric	ZCE05
+01-S7-W1	1	1001326	Prefab cable, PVC, 5 meter, connector M12 male 90°+ M12 female 90°, 4-pole	Murrelektronik	PVC-OB 4x0,34mm2
+01-S7-W1	1	1001600	Prefab cable, PVC, 10 meter, connector M12 male 90°+ M12 female 90°, 4-pole	Murrelektronik	PVC-OB 4x0,34mm2
+01-S7-W1	1	1006487	Prefab cable, PVC, 15 meter, connector M12 male 90°+ M12 female 90°, 4-pole	Murrelektronik	PVC-OB 4x0,34mm2
+01-S8	1	AE0005524	Limit switch basic contact element, M12 connector	Schneider Electric	ZCMD21C12
+01-S8	1	AE0005537	Limit switch lever	Schneider Electric	ZCY54
+01-S8	1	AE0005534	Limit switch control head	Schneider Electric	ZCE05
+01-S8-W1	1	1001601	Prefab cable, PVC, 1 meter, connector M12 male 90°+ M12 female 90°, 4-pole	Murrelektronik	PVC-OB 4x0,34mm2
+01-U0	1	1003309	Passive plug-in terminal, 8-fold, 5-pole, M12	Murrelektronik	Exact12 8xM12 5-p
+02-M1	1		See specification sheet		
+03-B5	1	1005663	Reflex sensor	Sick	GL6-P4211
+03-B5	1	1003575	Reflector	Sick	PL20A
+03-B5-W1	1	1003307	Prefab cable, PVC, 1 meter, connector M12 male + female M8, 4-pole	Murrelektronik	PVC-OB 4x0,25mm2
+03-B6	1	1005663	Reflex sensor	Sick	GL6-P4211
+03-B6	1	1003575	Reflector	Sick	PL20A
+03-B6-W1	1	1003307	Prefab cable, PVC, 1 meter, connector M12 male + female M8, 4-pole	Murrelektronik	PVC-OB 4x0,25mm2
+03-B13	1	1005663	Reflex sensor	Sick	GL6-P4211
+03-B13	1	1003575	Reflector	Sick	PL20A

Parts list

Position	Quantity	Article number	Description	Manufacturer	Type number
+03-B13-W1	1	1003307	Prefab cable, PVC, 1 meter, connector M12 male + female M8, 4-pole	Murrelektronik	PVC-OB 4x0,25mm2
+03-B14	1	1000932	Inductive proximity sensor	Sick	IME18-08BPSZC0K
+03-B14-W1	1	AE0118544	Prefab cable, PVC, 0,3 meter, connector M12 male + M12 female 90°, 4-pole	Murrelektronik	PVC-OB 4x0,34mm2
+03-U5	1	1003313	T-Coupler 5p Male M12 / 2x 4p Female M12, Distribution function	Murrelektronik	T-Coupler5p Male M12 / 2x 4p Female M12
+03-U5-W1	1	1001599	Prefab cable, PUR, 5 meter, connector M12 male 90°+ M12 female 90°, 4-pole	Murrelektronik	PUR-OB 4x0,34mm2
+03-U5-W1	1	1004351	Prefab cable, PUR, 10 meter, connector M12 male 90°+ M12 female 90°, 4-pole	Murrelektronik	PUR-OB 4x0,34mm2
+03-U5-W1	1	1006494	Prefab cable, PUR, 15 meter, connector M12 male 90°+ M12 female 90°, 4-pole	Murrelektronik	PUR-OB 4x0,34mm2
+03-U6	1	1003313	T-Coupler 5p Male M12 / 2x 4p Female M12, Distribution function	Murrelektronik	T-Coupler5p Male M12 / 2x 4p Female M12
+03-U6-W1	1	1001599	Prefab cable, PUR, 5 meter, connector M12 male 90°+ M12 female 90°, 4-pole	Murrelektronik	PUR-OB 4x0,34mm2
+03-U6-W1	1	1004351	Prefab cable, PUR, 10 meter, connector M12 male 90°+ M12 female 90°, 4-pole	Murrelektronik	PUR-OB 4x0,34mm2
+03-U6-W1	1	1006494	Prefab cable, PUR, 15 meter, connector M12 male 90°+ M12 female 90°, 4-pole	Murrelektronik	PUR-OB 4x0,34mm2
+04-M1	2		See specification sheet		
+04-U10	1		See specification sheet		

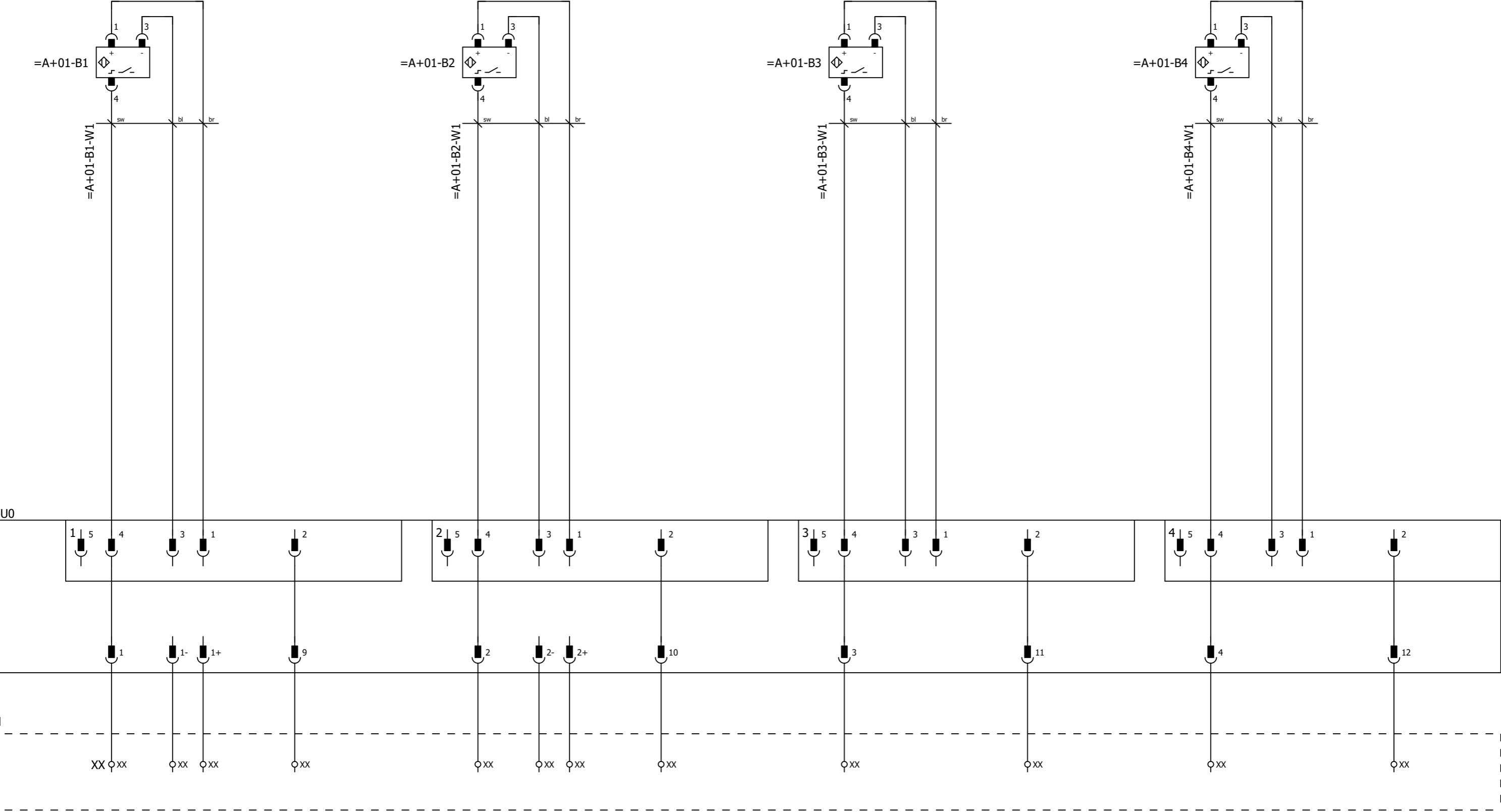

Passive plug-in terminal Prorunner mk1 Bottom stop position Spare Bottom low speed position Spare Top stop position Spare Top low speed position Spare

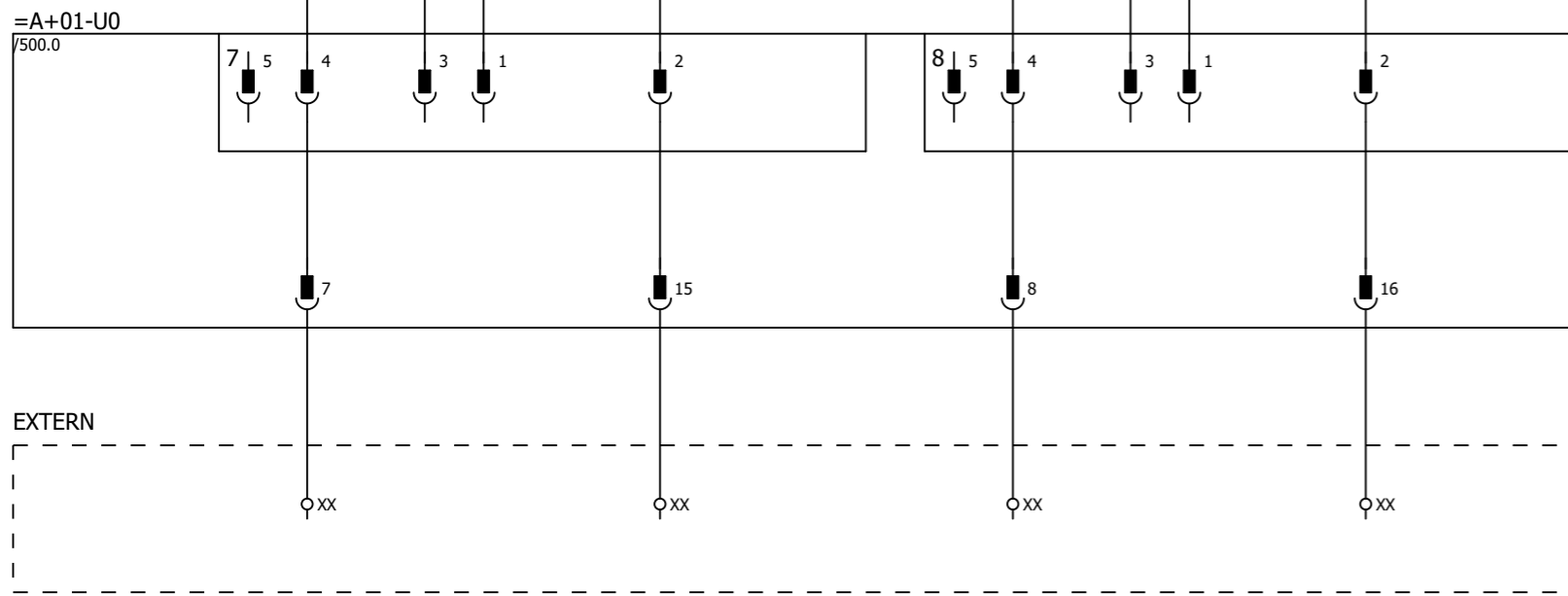
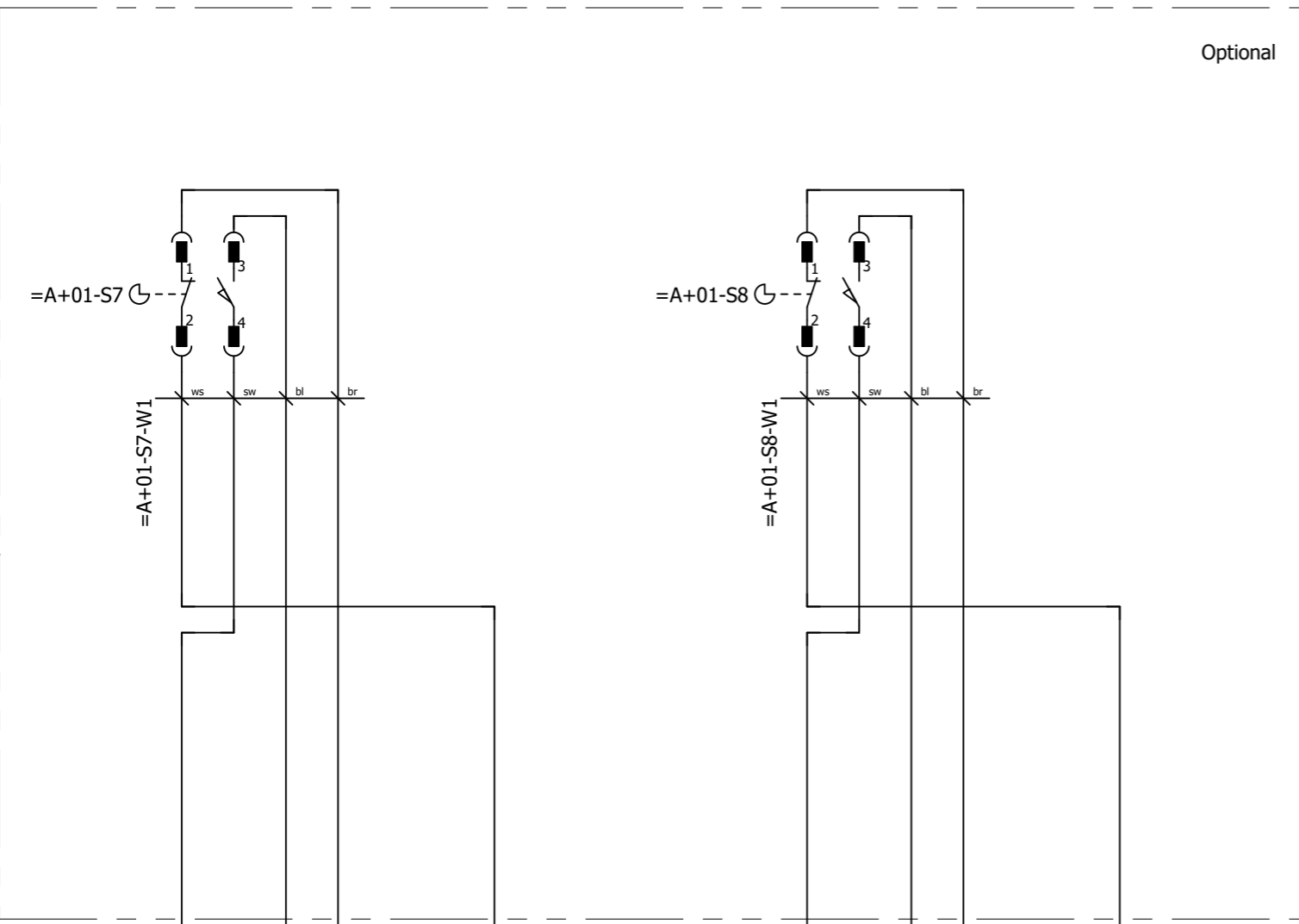

Passive plug-in terminal Prorunner mk1	Bottom limit switch (Not in use, not possible)	Bottom limit switch	Top limit switch (Not in use, not possible)	Top limit switch	Optional
--	--	---------------------	---	------------------	----------

For technical specifications of gearmotor, applied options, machine configuration and other data see specification sheet.

EXTERN

Alternative

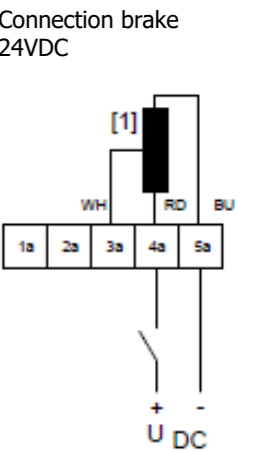
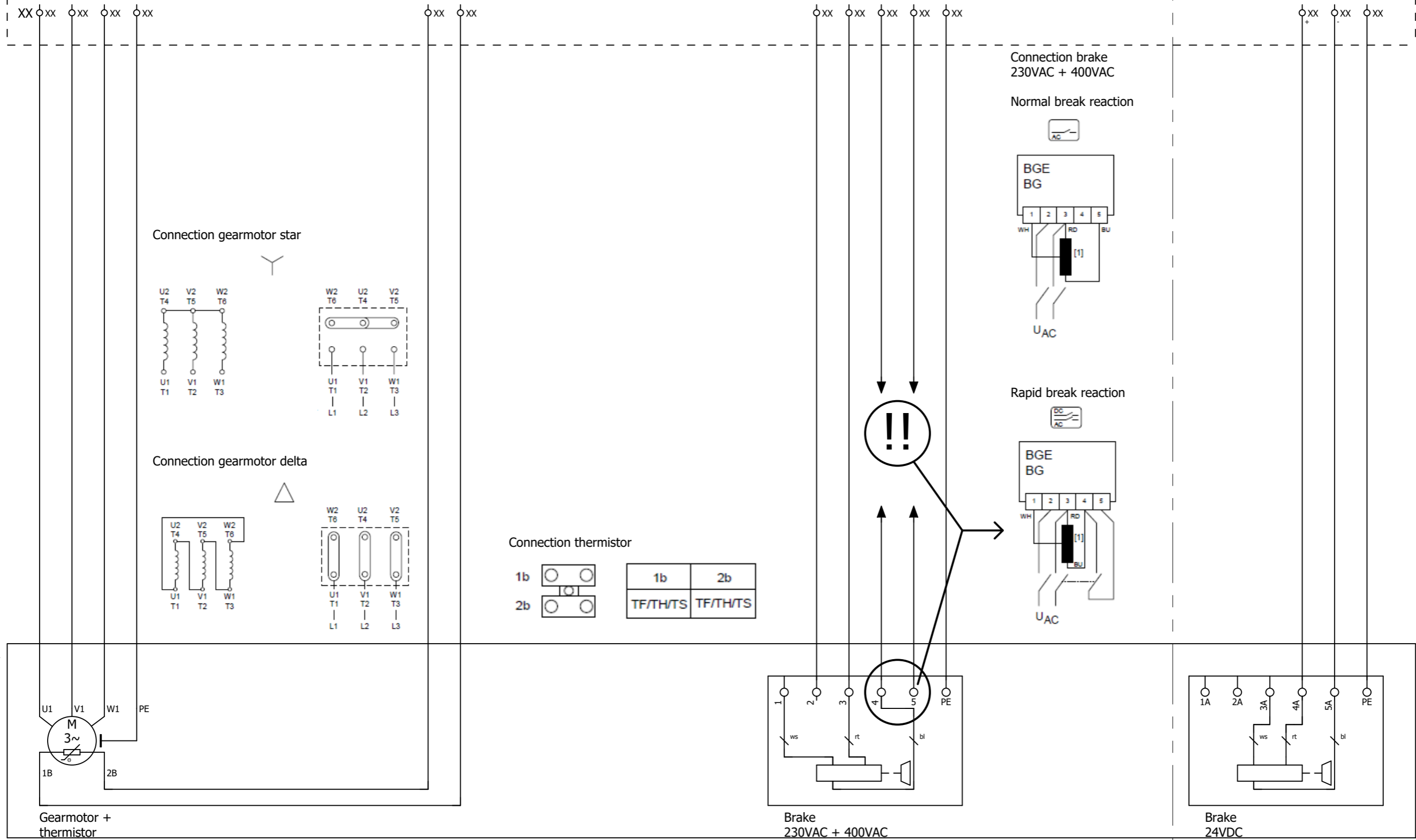

=A+02-M1

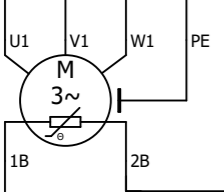

Gearmotor + thermistor

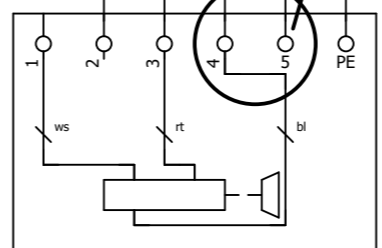

Brake 230VAC + 400VAC

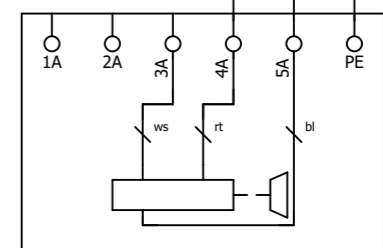

Brake 24VDC

Gearmotor Prorunner mk1

For technical specifications of gearmotor, applied options, machine configuration and other data see specification sheet.

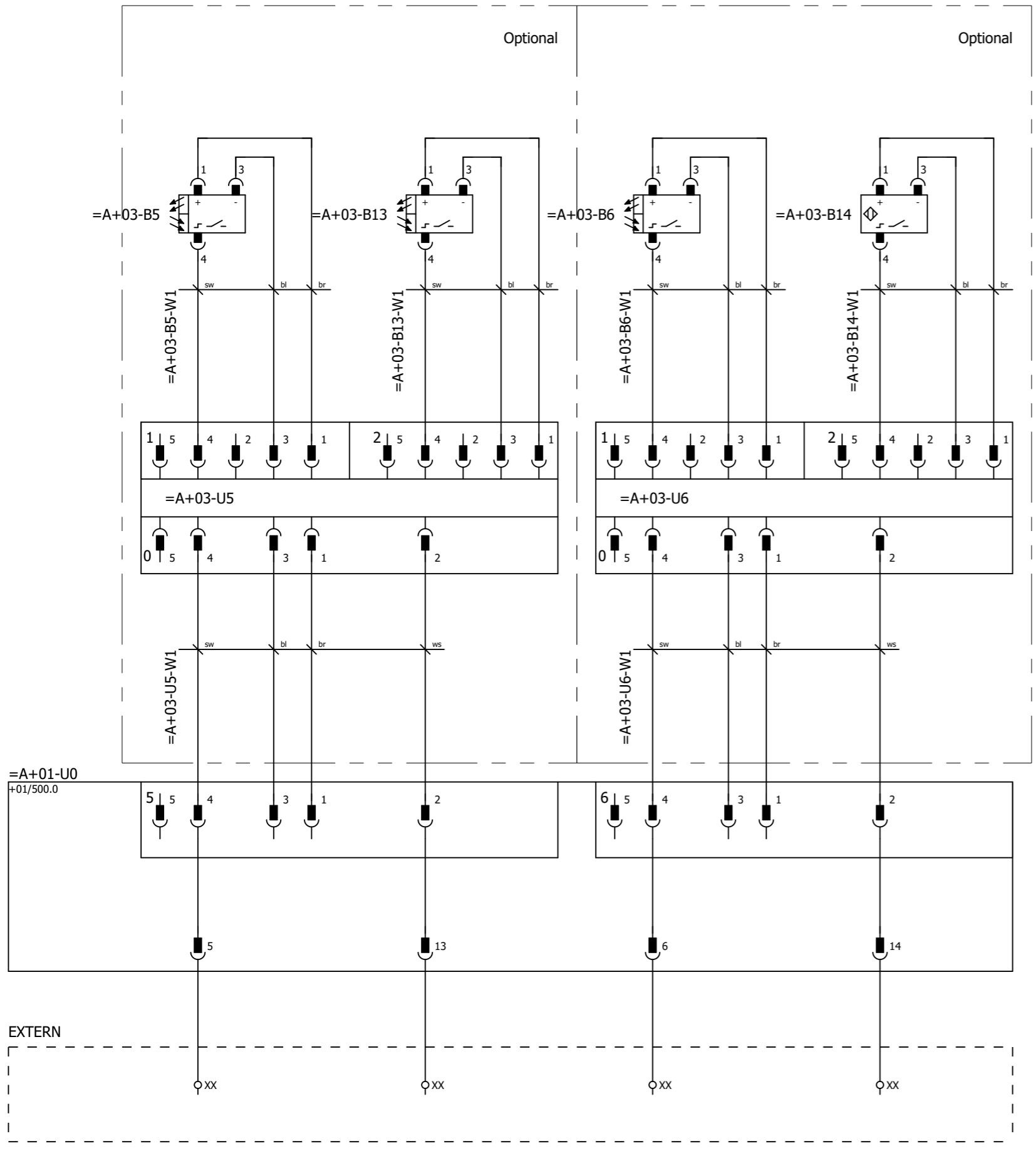

Passive plug-in terminal Prorunner mk1	Detection carrier not free 1	Optional Detection carrier not free 2	Product on conveyor	Optional Belt slack detection ok
---	------------------------------	--	---------------------	-------------------------------------

For technical specifications of gearmotor, applied options, machine configuration and other data see specification sheet.



Description of the project
Prorunner mk1
Standard

Page description
Field components

Mounting group	Prorunner mk1
Mounting location	Detection conveyor on carrier

Ed.	DSP	=	A
Date	11-11-2020	+	03
Version	v6.8		
			Page 501

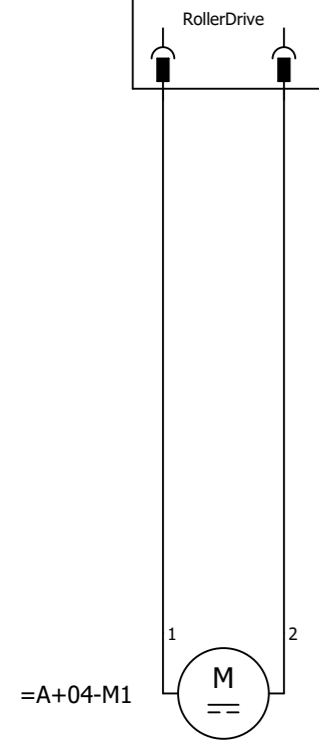
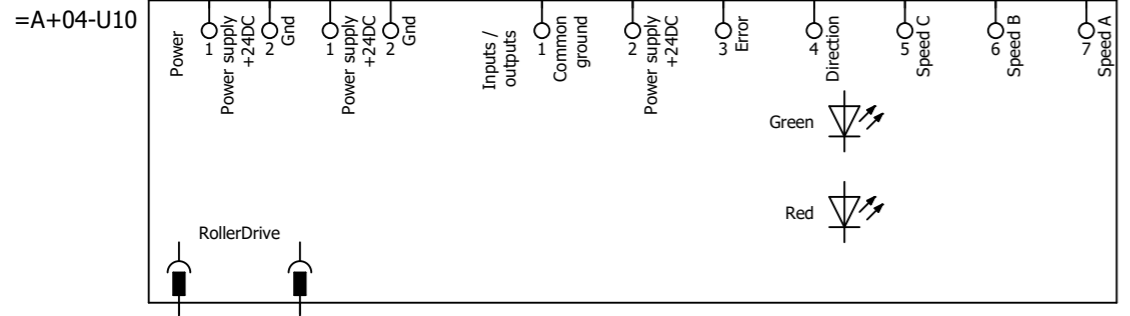
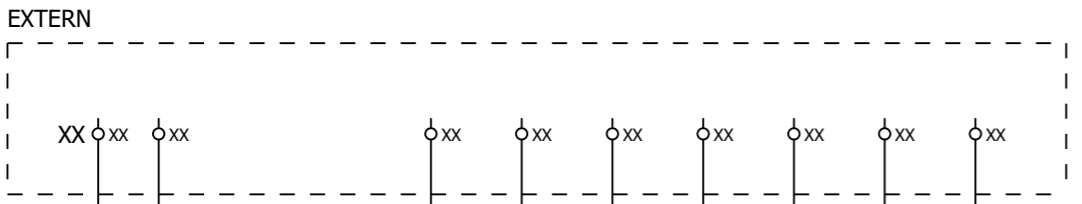

Rollerdrive conveyor on carrier

For technical specifications of gearmotor, applied options, machine configuration and other data see specification sheet.

EXTERN

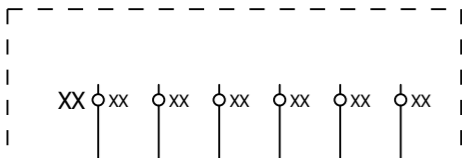

=A+04-M1

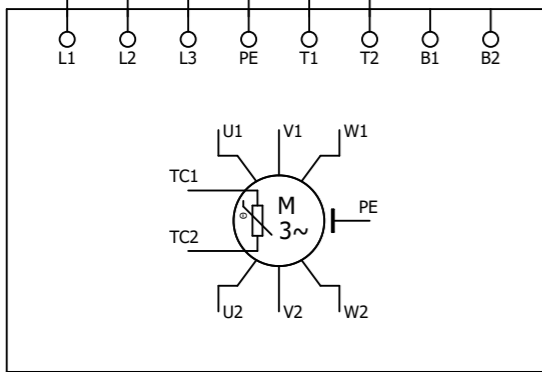

Drummotor conveyor on carrier

Optional

For technical specifications of gearmotor, machine configuration and other data see specification sheet.



Nobelstraat 43
3846 CE Harderwijk
The Netherlands

Phone: +31 341 - 436700
Fax: +31 341 - 436701
www.qimarox.com
info@qimarox.com

Document name: Electrical drawings PRmk1 v6.8
Mounting group: Extra stop positions (Optional)
Type: Standard

This section only applies if there are more than two stop positions.







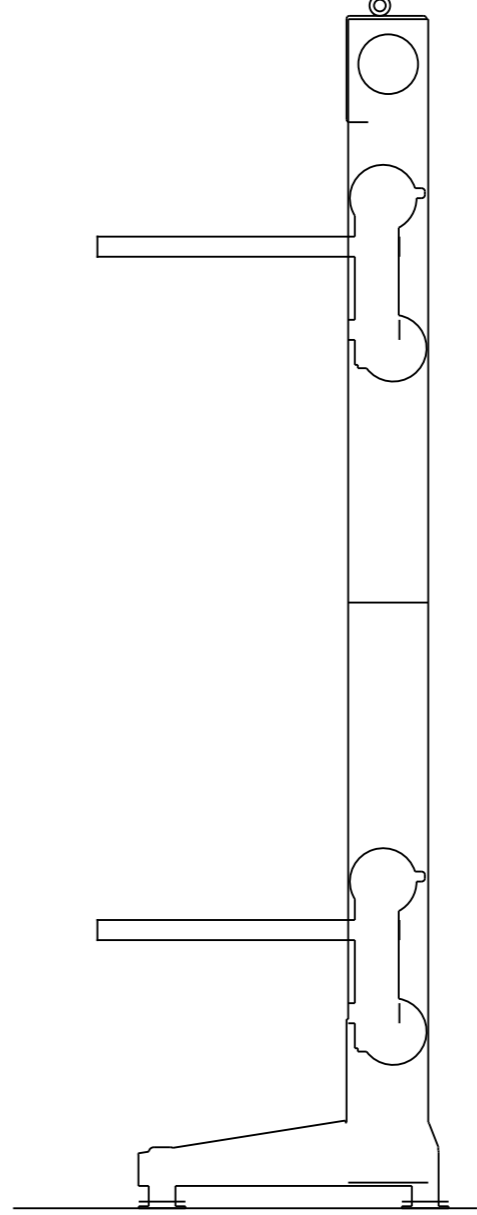
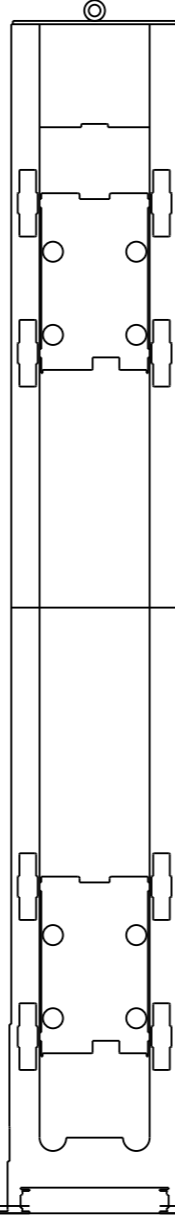
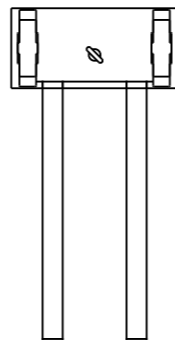

Power supply: See specification sheet
Control voltage: 24VDC
According to: NEN-EN-IEC 60204-1: 2018

Version number: v6.8

Table of contents

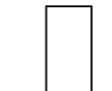
Mounting group		Mounting location		Page	Page description
=B	Extra stop positions (Optional)			1	Title page
				2	Table of contents
				10	Layout extra stop positions
				20	Overview passive plug-in terminal extra stop positions
				2000	Parts list
		+05	Detection extra stop positions	500	Field components
		+05	Detection extra stop positions	501	Field components



-  =B+05-B8
-  =B+05-B7
-  =B+05-B6
-  =B+05-B5
-  =B+05-U0
-  =B+05-B4
-  =B+05-B3
-  =B+05-B2
-  =B+05-B1

Legend:

- =B+05-B1 Extra position 1 low speed up / stop down
- =B+05-B2 Extra position 1 stop up / low speed down
- =B+05-B3 Extra position 2 low speed up / stop down
- =B+05-B4 Extra position 2 stop up / low speed down
- =B+05-B5 Extra position 3 low speed up / stop down
- =B+05-B6 Extra position 3 stop up / low speed down
- =B+05-B7 Extra position 4 low speed up / stop down
- =B+05-B8 Extra position 4 stop up / low speed down
- =B+05-U0 Passive plug-in terminal extra stop positions

For technical specifications of gearmotor, applied options, machine configuration and other data see specification sheet.

Image may differ from reality.

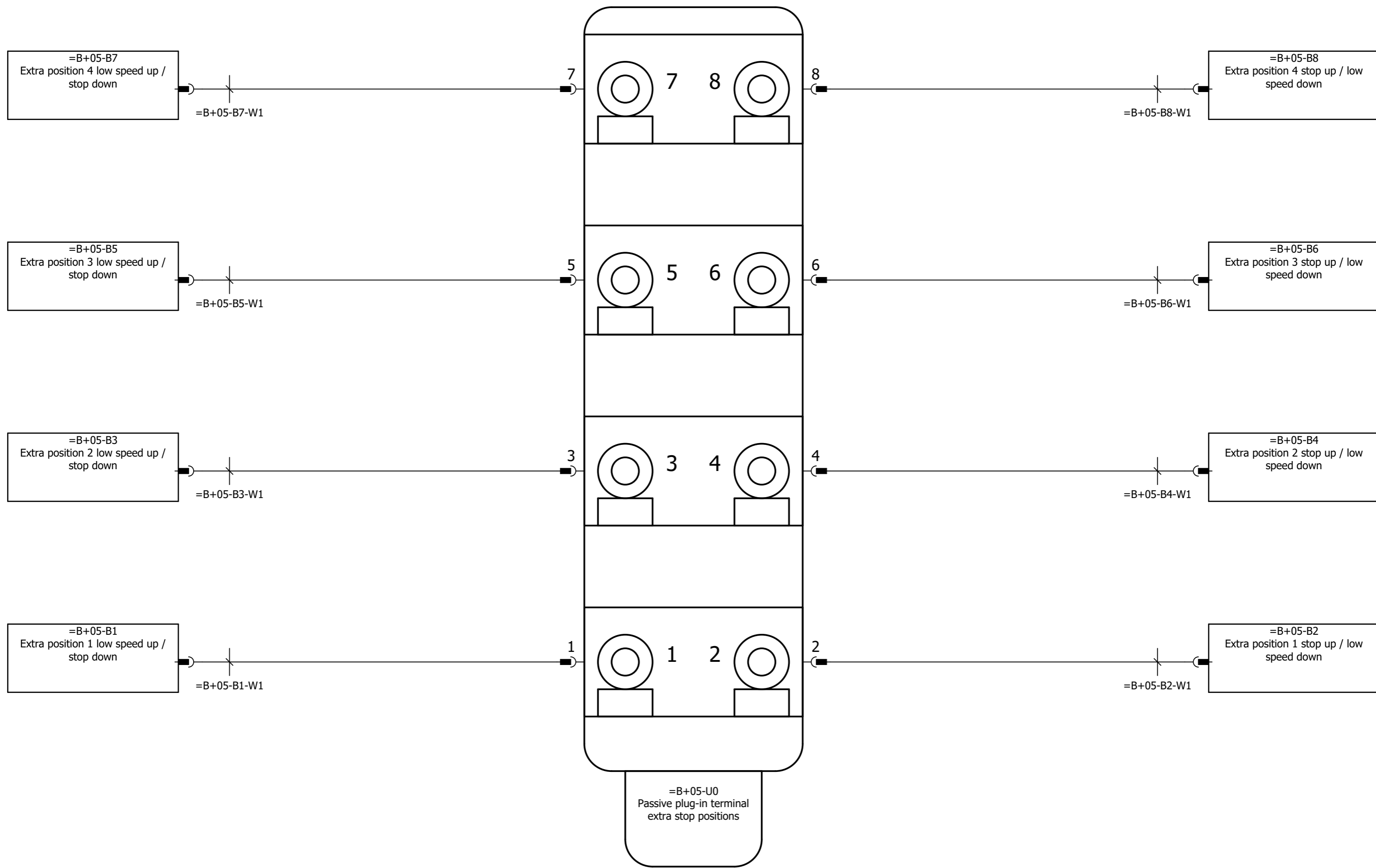

For technical specifications of gearmotor, applied options, machine configuration and other data see specification sheet.

Parts list

Position	Quantity	Article number	Description	Manufacturer	Type number
+05-B1	1	1000932	Inductive proximity sensor	Sick	IME18-08BPSZC0K
+05-B1-W1	1	1001326	Prefab cable, PVC, 5 meter, connector M12 male 90°+ M12 female 90°, 4-pole	Murrelektronik	PVC-OB 4x0,34mm2
+05-B1-W1	1	1001600	Prefab cable, PVC, 10 meter, connector M12 male 90°+ M12 female 90°, 4-pole	Murrelektronik	PVC-OB 4x0,34mm2
+05-B1-W1	1	1006487	Prefab cable, PVC, 15 meter, connector M12 male 90°+ M12 female 90°, 4-pole	Murrelektronik	PVC-OB 4x0,34mm2
+05-B2	1	1000932	Inductive proximity sensor	Sick	IME18-08BPSZC0K
+05-B2-W1	1	1001326	Prefab cable, PVC, 5 meter, connector M12 male 90°+ M12 female 90°, 4-pole	Murrelektronik	PVC-OB 4x0,34mm2
+05-B2-W1	1	1001600	Prefab cable, PVC, 10 meter, connector M12 male 90°+ M12 female 90°, 4-pole	Murrelektronik	PVC-OB 4x0,34mm2
+05-B2-W1	1	1006487	Prefab cable, PVC, 15 meter, connector M12 male 90°+ M12 female 90°, 4-pole	Murrelektronik	PVC-OB 4x0,34mm2
+05-B3	1	1000932	Inductive proximity sensor	Sick	IME18-08BPSZC0K
+05-B3-W1	1	1001326	Prefab cable, PVC, 5 meter, connector M12 male 90°+ M12 female 90°, 4-pole	Murrelektronik	PVC-OB 4x0,34mm2
+05-B3-W1	1	1001600	Prefab cable, PVC, 10 meter, connector M12 male 90°+ M12 female 90°, 4-pole	Murrelektronik	PVC-OB 4x0,34mm2
+05-B3-W1	1	1006487	Prefab cable, PVC, 15 meter, connector M12 male 90°+ M12 female 90°, 4-pole	Murrelektronik	PVC-OB 4x0,34mm2
+05-B4	1	1000932	Inductive proximity sensor	Sick	IME18-08BPSZC0K
+05-B4-W1	1	1001326	Prefab cable, PVC, 5 meter, connector M12 male 90°+ M12 female 90°, 4-pole	Murrelektronik	PVC-OB 4x0,34mm2
+05-B4-W1	1	1001600	Prefab cable, PVC, 10 meter, connector M12 male 90°+ M12 female 90°, 4-pole	Murrelektronik	PVC-OB 4x0,34mm2
+05-B4-W1	1	1006487	Prefab cable, PVC, 15 meter, connector M12 male 90°+ M12 female 90°, 4-pole	Murrelektronik	PVC-OB 4x0,34mm2
+05-B5	1	1000932	Inductive proximity sensor	Sick	IME18-08BPSZC0K
+05-B5-W1	1	1001326	Prefab cable, PVC, 5 meter, connector M12 male 90°+ M12 female 90°, 4-pole	Murrelektronik	PVC-OB 4x0,34mm2
+05-B5-W1	1	1001600	Prefab cable, PVC, 10 meter, connector M12 male 90°+ M12 female 90°, 4-pole	Murrelektronik	PVC-OB 4x0,34mm2
+05-B5-W1	1	1006487	Prefab cable, PVC, 15 meter, connector M12 male 90°+ M12 female 90°, 4-pole	Murrelektronik	PVC-OB 4x0,34mm2
+05-B6	1	1000932	Inductive proximity sensor	Sick	IME18-08BPSZC0K
+05-B6-W1	1	1001326	Prefab cable, PVC, 5 meter, connector M12 male 90°+ M12 female 90°, 4-pole	Murrelektronik	PVC-OB 4x0,34mm2
+05-B6-W1	1	1001600	Prefab cable, PVC, 10 meter, connector M12 male 90°+ M12 female 90°, 4-pole	Murrelektronik	PVC-OB 4x0,34mm2
+05-B6-W1	1	1006487	Prefab cable, PVC, 15 meter, connector M12 male 90°+ M12 female 90°, 4-pole	Murrelektronik	PVC-OB 4x0,34mm2
+05-B7	1	1000932	Inductive proximity sensor	Sick	IME18-08BPSZC0K
+05-B7-W1	1	1001326	Prefab cable, PVC, 5 meter, connector M12 male 90°+ M12 female 90°, 4-pole	Murrelektronik	PVC-OB 4x0,34mm2
+05-B7-W1	1	1001600	Prefab cable, PVC, 10 meter, connector M12 male 90°+ M12 female 90°, 4-pole	Murrelektronik	PVC-OB 4x0,34mm2
+05-B7-W1	1	1006487	Prefab cable, PVC, 15 meter, connector M12 male 90°+ M12 female 90°, 4-pole	Murrelektronik	PVC-OB 4x0,34mm2
+05-B8	1	1000932	Inductive proximity sensor	Sick	IME18-08BPSZC0K
+05-B8-W1	1	1001326	Prefab cable, PVC, 5 meter, connector M12 male 90°+ M12 female 90°, 4-pole	Murrelektronik	PVC-OB 4x0,34mm2
+05-B8-W1	1	1001600	Prefab cable, PVC, 10 meter, connector M12 male 90°+ M12 female 90°, 4-pole	Murrelektronik	PVC-OB 4x0,34mm2
+05-B8-W1	1	1006487	Prefab cable, PVC, 15 meter, connector M12 male 90°+ M12 female 90°, 4-pole	Murrelektronik	PVC-OB 4x0,34mm2
+05-U0	1	1003309	Passive plug-in terminal, 8-fold, 5-pole, M12	Murrelektronik	Exact12 8xM12 5-p

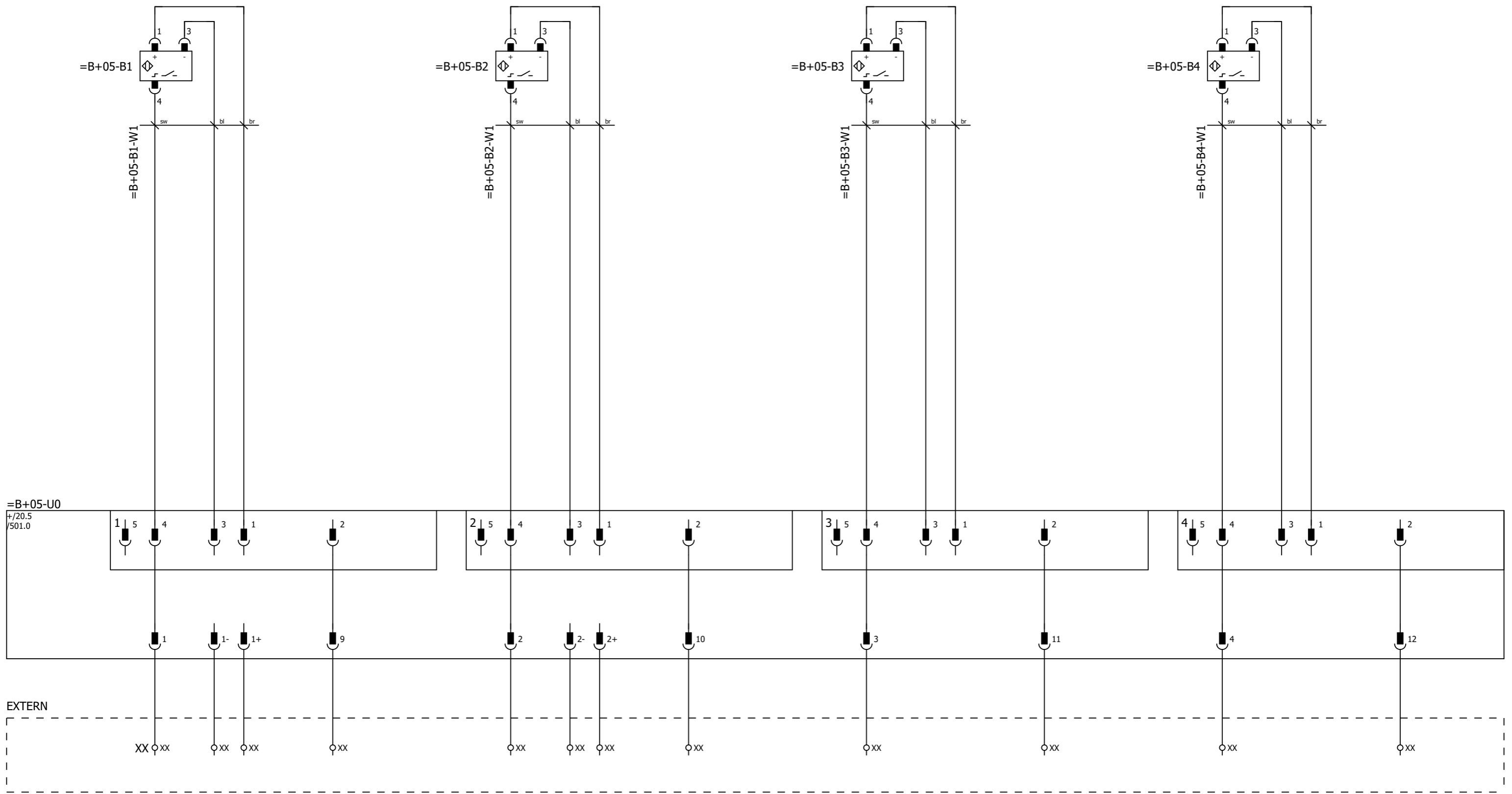

Passive plug-in terminal extra stop positions Extra position 1 low speed up / stop down Spare Extra position 1 stop up / low speed down Spare Extra position 2 low speed up / stop down Spare Extra position 2 stop up / low speed down Spare

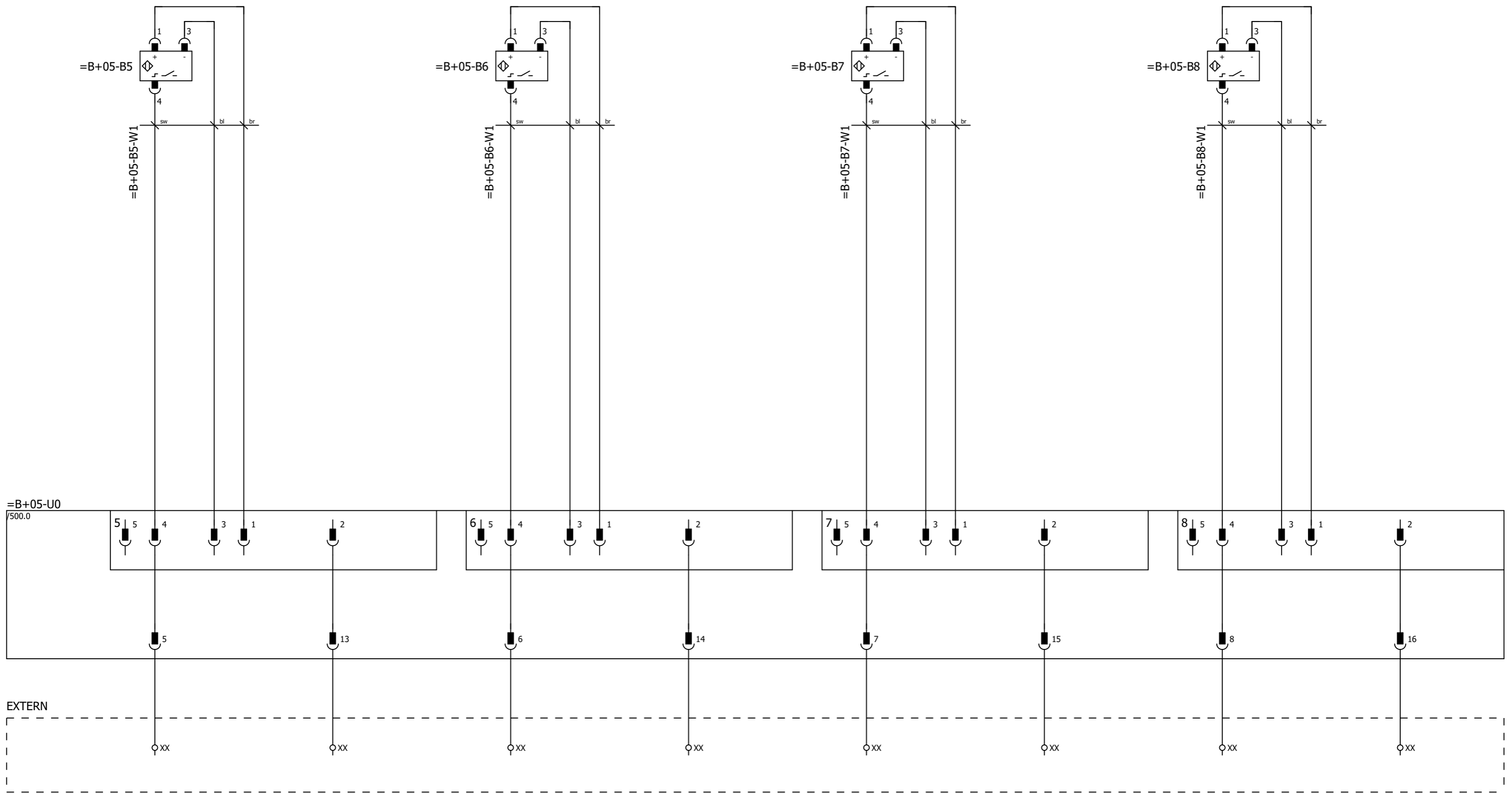

Passive plug-in terminal extra stop positions Extra position 3 low speed up / stop down Spare Extra position 3 stop up / low speed down Spare Extra position 4 low speed up / stop down Spare Extra position 4 stop up / low speed down Spare