

Operating manual

RollerDrive EC5000 AI/BI

24 V/48 V DC, Analogue Interface/Bus Interface

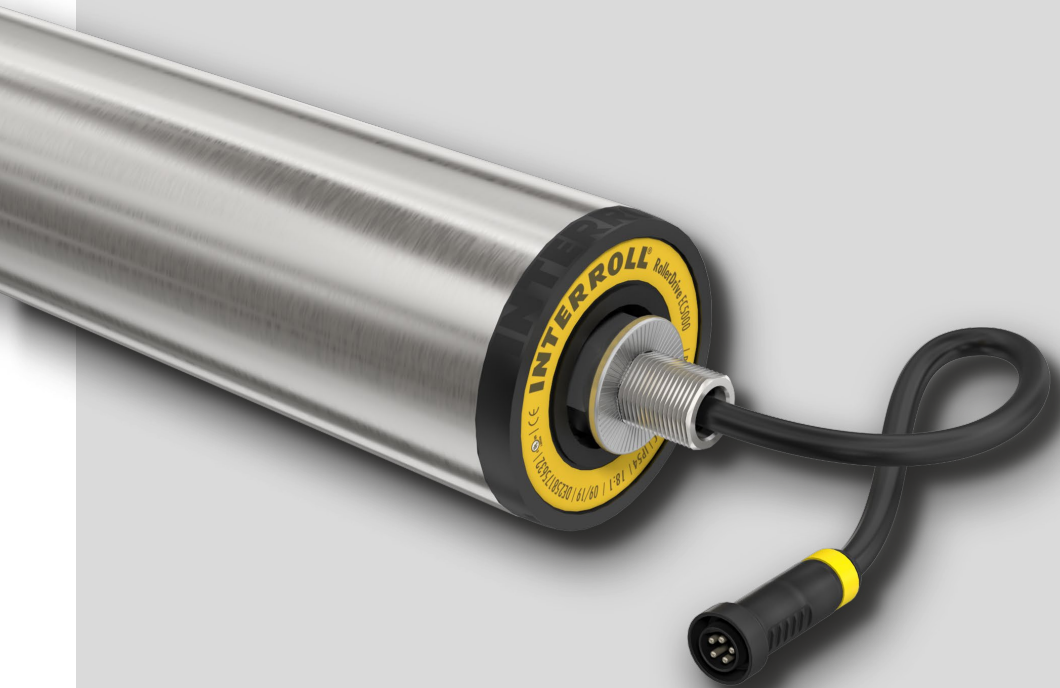

Manufacturer details

Interroll Engineering GmbH
Höferhof 16
42929 Wermelskirchen
Germany
Tel.: +49 (0) 2193 23 0
Fax: +49 (0) 2193 2022
www.interroll.com

Content

We strive for the accuracy, timeliness and completeness of the information and have carefully prepared the contents in this document. Regardless of this, errors and changes are expressly reserved.

Copyright/industrial property rights

Any texts, images, graphics and the like, as well as their arrangement, are subject to protection under copyright and other laws of protection. The reproduction, modification, transmission or publication of any part of this document or of the entire document in any form is prohibited.

The document serves the exclusive purposes of information and of operation in accordance with the regulations and does not justify any counterfeiting of the products concerned.

All signs contained in this document (protected marks, such as logos and trade names) are the property of Interroll Holding AG, CH or of third parties and must not be used, copied or distributed without prior written consent.

Online version - only suitable for color printing!

1	About this document	7
1.1	Information about this operating manual	7
1.2	Warning notices in this document	8
1.3	Symbols	9
2	Safety-related information	10
2.1	State of the art	10
2.2	Proper use	10
	Application field	10
2.3	Improper use	11
2.4	Qualification of personnel	11
2.5	Dangers	12
	Injury to persons	12
	Electricity	12
	Rotating parts	12
	Heat	12
	Work environment	12
	Faults in operation	12
	Maintenance	13
	Unintentional start-up	13
2.6	Interface to other devices	13
2.7	Operating modes/operating phases	13
	Standard operation	13
	Special operation	13
2.8	Applicable documentation	14
3	Product information	15
3.1	Components	15
	Colour rings on the connectors	15
3.2	Product description	16
	Overload protection	16
3.3	RollerDrive EC5000 BI with CAN bus	18
	Service life indicator lights	18
	Health indicator lights	19
	Various operating modes	20

Contents

3.4	Rating plate	21
3.5	RollerDrive EC5000 as a replacement for RollerDrive EC310	22
3.6	Product identification	23
3.7	Technical specifications	24
	EC5000 20 W – AI/BI – 24 V DC	24
	EC5000 35 W – AI/BI – 24 V DC	25
	EC5000 50 W – AI/BI – 24 V DC	26
	EC5000 20 W – AI/BI – 48 V DC	27
	EC5000 35 W – AI/BI – 48 V DC	28
	EC5000 50 W – AI/BI – 48 V DC	29
3.8	Performance data	30
	EC5000 20 W – 24 V DC/48 V DC	30
	EC5000 35 W – 24 V DC/48 V DC	31
	EC5000 50 W – 24 V DC/48 V DC	32
3.9	Control systems for the RollerDrive EC5000	33
3.10	RollerDrive connector AI	34
3.11	RollerDrive connector BI	35
3.12	Dimensions of the motor shaft	36
3.13	Dimensions of the bearing housings on the non-cable side	36
	EC5000 IP66	38
4	Transport and storage	39
4.1	Transport	39
4.2	Storage	39
5	Assembly and installation	40
5.1	Warning notices for installation	40
5.2	Installing the RollerDrive	41
	Installing the attachment shaft	41
	Attaching the non-cable side	42
	Securing the RollerDrive in the side profile	43
	The Interroll Interlock (optional)	44
5.3	Installation tool (accessory)	45
5.4	Warning notices for electrical installation	46
5.5	Electrical installation	46

6	Start-up and operation	47
6.1	Warning notices for start-up and operation	47
6.2	Start-up	47
	Check before the initial start-up	47
6.3	Operation	48
	Check before every start-up	48
6.4	Procedure in the event of accidents or faults	48
7	Maintenance and cleaning	49
7.1	Maintenance	49
	Checking the RollerDrive	49
	Replacing the RollerDrive	49
7.2	Cleaning	50
8	Assistance in the event of faults	51
8.1	Troubleshooting	51
9	Decommissioning and disposal	52
9.1	Decommissioning	52
9.2	Disposal	52
10	Appendix	53
10.1	Accessories	53
	Interroll control systems	53
	Interroll High Performance power supply unit	53
	RollerDrive extension cable	53
	PolyVee belt	54
	PolyVee clamping aid	54
	PolyVee finger guard	54
	Tool	54
10.2	Translation of the original Declaration of Conformity	55



1 About this document

1.1 Information about this operating manual

This operating manual covers the following Interroll motor rollers:

- RollerDrive EC5000 AI with analogue interface, 24 V DC and 48 V DC
- RollerDrive EC5000 BI with digital CANopen bus interface, 24 V DC and 48 V DC

in three different power levels (see „Product description“ on page 16).

In the course of this manual, the term "RollerDrive" will sometimes be used, or alternatively the type designation "EC5000".

The operating manual is a component of the product and contains important advice and information regarding the different operating phases of the RollerDrive. It describes the RollerDrive at the time of shipping from Interroll.

The currently applicable version of this operating manual can be found online at: www.interroll.com/support/

All the information and advice in this operating manual has been compiled with respect to applicable standards and regulations as well as the current state of the art.

For special versions, in addition to this operating manual, particular contractual arrangements and technical documents apply.

- To ensure safe and faultless operation and to fulfil any warranty claims that may apply, read this operating manual first and observe its instructions.
- Keep this operating manual within close reach of the RollerDrive.
- Pass this operating manual onto every subsequent owner or user.



The manufacturer assumes no liability for damage and malfunctions that occur as a result of non-compliance with this operating manual.



Should you still have any unanswered questions after reading this operating manual, please contact Interroll customer service. Contact details for your region can be found online at www.interroll.com/contact/

Please direct any comments and suggestions regarding our operating manuals to manuals@interroll.com

About this document

1.2 Warning notices in this document

Warning notices are provided in the context in which danger can occur and describe the nature of the danger in question. They are structured according to the following examples:



SIGNAL WORD

Type and source of hazard

Consequence(s) in the event of non-compliance

➤ Measure(s) for avoiding hazard

Signal words indicate the type and severity of the consequences if measures to avoid the hazard are not observed.



DANGER

Denotes an imminent hazard.

If measures to avoid the hazard are not observed, death or severe injury will occur.

➤ Preventive measures



WARNING

Denotes a potentially hazardous situation.

If measures to avoid the hazard are not observed, death or severe injury may occur.

➤ Preventive measures



CAUTION

Denotes the possibility of a hazardous situation.

If measures to avoid the hazard are not observed, minor or moderate injury may occur.

➤ Preventive measures

NOTE

Denotes a situation that can lead to material damage.

- Preventive measures
-

1.3 Symbols



This symbol indicates useful and important information.

- ✓ This symbol indicates a requirement that must be fulfilled before carrying out assembly or repair work.



This symbol indicates general information relating to safety.

- This symbol indicates an action that needs to be performed.
- This symbol indicates a listed item.

Safety-related information

2 Safety-related information

2.1 State of the art

The RollerDrive EC5000 has been constructed with respect to applicable standards and the current state of the art and has been delivered in a condition that is safe to operate. Nevertheless, hazards can occur as a result of use.



Non-compliance with the instructions in this operating manual can result in life-threatening injuries.

In addition, the applicable local accident prevention regulations for the area of application and general safety regulations must be adhered to.

2.2 Proper use

The RollerDrive may only be used in an industrial environment for industrial purposes within the stipulated performance limits that are given in the technical specifications.

It must be integrated into a conveyor unit or conveyor system before commissioning.

Application field

Drive for unit load conveyor technology, such as for the transportation of cardboard boxes, containers, barrels, workpiece carriers or tyres.

The RollerDrive is suitable for:

- Zero-pressure roller conveyors
- Entry conveyors
- Roller conveyor curves
- Small belt conveyors

Depending on the area of application of the RollerDrive, PolyVee, round or toothed belts as well as chains can be used for the power transmission.

2.3 Improper use

Any use that goes beyond the proper use is considered improper, unless this has been authorised by Interroll Engineering GmbH where applicable.

Any modification by conversion to the RollerDrive or attachment to the RollerDrive is prohibited!

The equipment must not be installed in areas in which substances could form explosive atmospheres/dust atmospheres or for application in the medical/pharmaceutical sector.

It is considered improper use to install the equipment in exposed spaces that are open to potentially adverse weather conditions, or areas in which the technology would suffer from the prevailing climactic conditions and could potentially malfunction as a result.

The RollerDrive is not intended for use by private end users. The equipment must not be used in a residential environment without further examination and without the use of EMC protective measures that have been adapted accordingly.

The RollerDrive is not suitable for transporting people.

It must not be used as a safety-relevant component or for performing safety-relevant functions.

2.4 Qualification of personnel

Non-qualified personnel are unable to identify risks and are therefore exposed to higher levels of danger.

- Only qualified personnel may be assigned with the tasks outlined in this operating manual.
- The operating company is responsible for ensuring that personnel adhere to the locally valid rules and regulations for working in a safe and risk-aware manner.

This operating manual is intended for the following target audiences:

Operators

Operators are trained in how to operate and clean the Interroll RollerDrive and follow the safety regulations.

Service engineers

The service engineers have a specialist technical education or have successfully completed a training course from the manufacturer. They carry out repair and maintenance work.

Qualified electricians

Qualified electricians have a specialist technical education. Moreover, due to their knowledge and experience as well as knowledge of applicable regulations, they are able to carry out work on electrical equipment in an appropriate manner. They are able to identify hazards independently and prevent electrical damage to persons and property.

All work on electrical equipment must generally only be performed by a qualified electrician.

Safety-related information

2.5 Dangers



Here, you will find information about the different types of dangers or damage that can occur in connection with the operation of the RollerDrive.

Injury to persons

- Maintenance, installation and repair work on the unit must only be carried out by authorised technical personnel in compliance with the applicable provisions.
- Before switching on the RollerDrive, ensure that no unauthorised personnel are situated in the vicinity of the conveyor/conveying system.

Electricity

- Installation and repair work must only be carried out when the system has been disconnected from the power supply.
- Switch off the power to the RollerDrive and ensure that it cannot be unintentionally switched on again.

Rotating parts

- Keep fingers and hair away from moving parts.
- Persons with long hair should wear a hair net.
- Close-fitting work clothing should be worn.
- Do not wear items of jewellery such as necklaces or bands.

Heat

- Do not touch the RollerDrive during operation. In applications with high switching cycles, the temperature of the tube can reach up to 60 °C.

Work environment

- Remove any materials and objects that are not required from the working area.

Faults in operation

- Regularly check the RollerDrive for visible damage.
- In the event that smoke begins to form, unusual sounds are heard or the material to be conveyed becomes jammed or develops defects, switch off the power to the RollerDrive immediately and ensure that it cannot be unintentionally switched on again.
- Immediately contact specialist personnel to determine the cause of the malfunction.

Maintenance

- Since the product in question requires no maintenance, it is sufficient to simply examine the RollerDrive for visible damage on a regular basis.
- Never open up the RollerDrive.

Unintentional start-up

- Ensure that the RollerDrive cannot be switched on unintentionally, particularly during assembly and maintenance work or in the event of a fault.

2.6 Interface to other devices

The integration of the RollerDrive into a conveyor system can create additional potential hazards. Such potential hazards are not covered by this operating manual and must be analysed during the development, installation and commissioning of the conveyor system as a whole.

- Following the integration of the RollerDrive into a conveyor system, the entire system must be checked for any new potential hazards that may be present before the conveyor is switched on.

2.7 Operating modes/operating phases

Standard operation

Operation in the installed condition at the end customer as a component in a conveyor in an overall system.

Special operation

Special operation encompasses all operating modes/operating phases that are necessary to guarantee and maintain safe standard operation.

Special operating mode	Comments
Transport/storage	-
Assembly/commissioning	In de-energised state
Cleaning	In de-energised state
Maintenance/repair	In de-energised state
Fault location	-
Troubleshooting	In de-energised state
Decommissioning	In de-energised state
Disposal	-

Safety-related information

2.8 Applicable documentation

The RollerDrive EC5000 is part of the **Interroll DC Platform**, consisting of:

- Interroll High Performance power supply unit HP5424 or HP 5448 (24 V DC/48 V DC)
- Interroll MultiControl AI/BI
- RollerDrive EC5000 AI/BI (24 V DC/48 V DC)
- Interroll DriveControl 20/54/2048



Also ensure that you adhere to the information given in the operating manuals of the connected devices.

Further notes on operating and programming the RollerDrive can be found in the „MultiControl / RollerDrive - Start-up and Programming“ supplement.

The latest version of this supplement can be found online at: www.interroll.com/support/

3 Product information

3.1 Components

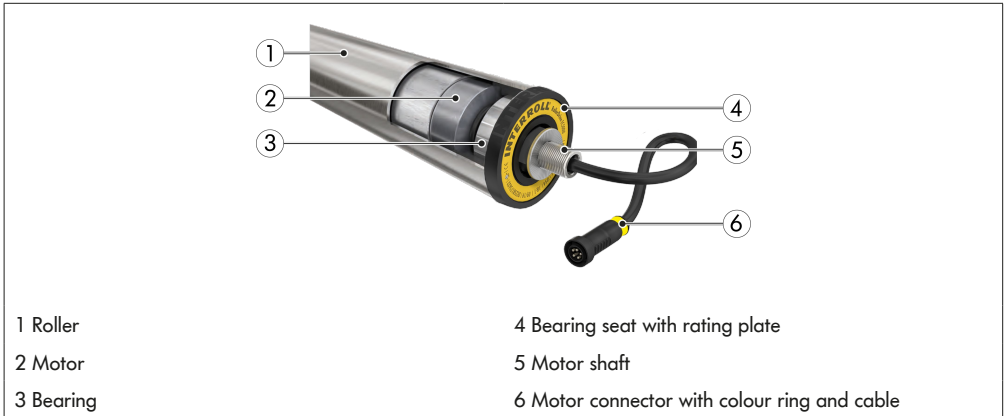

Colour rings on the connectors

The motor connector features a colour ring in order to make the various versions of the RollerDrive EC5000 easily distinguishable from one another.

Colour ring	RollerDrive version
White	Analogue interface, 24 V DC
Grey	Bus interface, 24 V DC
Black	Analogue interface, 48 V DC
Yellow	Bus interface, 48 V DC

Product information

3.2 Product description

The RollerDrive EC5000 can be used in both straight and curved sections and ensures a constant conveyor speed. Motors, motor electronics and gears are installed in the RollerDrive.

Both interface versions (analogue/CAN bus) of the RollerDrive EC5000 are available in three different power levels:

- 20 W
- 35 W
- 50 W

Overload protection

The EC5000 has multiple overload protection systems:

Stall timing

When the RollerDrive starts, the revolutions of the installed motor are monitored. If the motor does not reach a certain speed within a specified time, an error signal is set.

This error signal is automatically reset after 10 seconds.

How the EC5000 AI behaves: Once the target value is reapplied, the RollerDrive attempts to start again.

How the EC5000 BI behaves: The RollerDrive is ready to be acknowledged.

Heavy running detection

If the RollerDrive rotates 50% slower than specified for a defined period, an error signal is set.

In the case of the EC5000 BI, there is another adjustable warning limit with corresponding message before shutdown takes place.

The error signal is automatically reset after 10 seconds.

How the EC5000 AI behaves: Once the target value is reapplied, the RollerDrive attempts to start again.

How the EC5000 BI behaves: The RollerDrive is ready to be acknowledged.

Temperature monitoring

The temperature of the motor installed in the RollerDrive is monitored in addition to the temperature of the motor electronics. If the maximum permitted temperature is exceeded, the RollerDrive is switched off and an error signal is issued. Once the overheated components have cooled down, the error signal will be reset.

How the EC5000 AI behaves: Once the target value is reapplied, the RollerDrive attempts to start again.

How the EC5000 BI behaves: The RollerDrive is ready to be acknowledged.



WARNING

How the EC5000 AI behaves with overload protection:

The signals from the overload protection functions are automatically reset. If the target value is still applied, the RollerDrive may start up again unintentionally.

➤ Troubleshooting must be carried out via the control system.

Holding brake (zero motion hold)

The RollerDrive EC5000 is equipped with an electronic holding brake that allows it to be used in sloped and ascending conveyors.

EC5000 AI:

Holding brake active when no start signal is present.

EC5000 BI:

Holding brake active in "Operational" mode and target value "0".



If the power supply system fails, the holding brake will no longer take effect as the brake is not mechanical.

Energy recovery system

The RollerDrive recovers energy when braking the conveyed material. This results in the motor and motor electronics heating up less and improves the energy balance of the system. The Interroll control systems are equipped with a circuit that prevents an increase of voltage in the power supply.



If motor control systems are used without a voltage limiter (brake chopper), it must be ensured that the power supply units used are suitable for energy recovery ($\leq 35 \text{ V}$ / $\leq 60 \text{ V}$).

We recommend using the Interroll High Performance power supply units.

Product information

3.3 RollerDrive EC5000 BI with CAN bus

The CAN bus communication of the EC5000 BI is based on the following CAN/CANopen standards:

- ISO 11898-1 Road vehicles - Controller area network (CAN) - Part 1: Data link layer and physical signalling
- ISO 11898-2 Controller area network (CAN) - Part 2: High-speed medium access unit
- EN 50325 Industrial communications subsystem based on ISO 11898 (CAN) for controller-device interfaces - Part 1: General requirements
- CiA 402 CANopen device profile for drives and motion control

CAN bus communication enables, among other things, the actual values of the RollerDrive to be read out (monitoring), including:

- Number of starts/stops
- Operating hours (ready for operation)
- Runtime (time during which motor is rotating)
- Minimum temperature
- Maximum temperature
- Actual temperature
- Number of quick stops
- Average power
- Number of revolutions

So-called health indicator lights and service life indicator lights have also been integrated, which can be evaluated via the connected Interroll MultiControl BI or a connected PLC.

Service life indicator lights

In accordance with statistically determined reference values, a signal is output when the RollerDrive reaches a service life at which a replacement is recommended.

This is not a fixed value that decreases with the runtime.

The expected service life increases or decreases depending on the load on the RollerDrive.

The service life indicator lights have two statuses:

Green	The RollerDrive has not yet reached its expected service life.
Yellow	The RollerDrive has reached its expected service life. Replacement is recommended.
Red	This status is not used.

Health indicator lights

So-called health or status indicator lights are used to monitor the current values of the RollerDrive.

Health indicator lights are used to check the

- Temperature
- Power
- Frequency of errors

Temperature

Green	RollerDrive temperature OK.
Yellow	The temperature of the RollerDrive has reached the warning limit.
Red	The temperature of the RollerDrive has exceeded a critical value.

Power

Green	The RollerDrive is working within the specified power limits.
Yellow	The rated power of the RollerDrive has been exceeded.
Red	The power of the RollerDrive is > 120% of the rated power.

Frequency of errors

The frequency of the following errors is monitored within a specified time frame:

- Heavy running
- Stall timing
- Overvoltage
- Undervoltage

Green	Status of the RollerDrive OK.
Yellow	The number of errors within the specified time frame has reached the warning limit.
Red	The number of errors within the specified time frame has reached a critical limit.



The indicator lights are used purely for information purposes and do not result in the shutdown of the RollerDrive.

The signals can be evaluated and processed via the connected control system.

Product information

Various operating modes

The RollerDrive EC5000 BI can be operated in either speed or positioning mode.

This enables the RollerDrive to be moved with millimetre precision in certain applications.



For the positioning mode, the direction of rotation "clockwise" (default setting) must be selected in the default settings!

CAN bus default settings

Node ID: 127 (LSS mode for dynamic address assignment)

Baud rate: 250 kbps

Default acceleration values for the RollerDrive EC5000 BI

The EC5000 BI is supplied with the following acceleration values for an optimum acceleration ramp.

Gear	9:1	13:1	18:1	21:1	30:1	42:1	49:1	78:1	108:1
Acceleration value in mm/s ²	13,215	9149	6608	5664	3965	2832	2427	1525	1101

These values define the fastest possible acceleration and are entered in the RollerDrive in SDO object "6083h".

Object ID	Sub index	Name	Data type	Acc	Min.	Max.	Default	Mappable
6083h	00h	Profile acceleration	UINT32	rw	UINT32	UINT32	Gear-dependent	RM



Further information on the CAN bus can be found in the "Interroll MultiControl BI" operating manual and the "MultiControl / RollerDrive - Start-up and Programming" supplement.

The supplement document can be found in the download area at www.interroll.com

3.4 Rating plate

The information on the rating plate allows the RollerDrive to be identified. This is essential to be able to use the RollerDrive as intended.

Rating plate

1 Manufacturer	8 Electrical connected loads
2 Designation	9 Protection rate*
3 Type designation	10 Calendar week/year of manufacture
4 DF = Deep Frost (optional)	11 Serial number with country code
5 Mechanical power	12 CE marking
6 Interface type	13 UL marking (optional)
7 Gear ratio	

* For the option with UL marking, the type rating 2 is printed instead of the IP class

Product information

3.5 RollerDrive EC5000 as a replacement for RollerDrive EC310

The RollerDrive EC5000 24 V DC 20 W AI and EC5000 24 V DC 35 W AI are suitable as a replacement for RollerDrive EC310 without further modifications or accessories.

NOTE

Overload of the existing extension cable with RollerDrive EC5000 24 V DC 50 W AI

- When using the RollerDrive EC5000 24 V DC 50 W AI as a replacement for the RollerDrive EC310, any extension cables used must be replaced.



Note the different speeds as a result of the different rated speeds of the installed motors and different gear ratios.

To help you select the appropriate motor rollers, Interroll has provided a configurator at:

www.interroll.com

	RollerDrive EC310	RollerDrive EC5000
Motor rated speed	6000 rpm	6900 rpm
Gear stages	9:1	9:1
	12:1	13:1
	16:1	18:1
	20:1	21:1
	24:1	30:1
	36:1	42:1
	48:1	49:1
	64:1	78:1
	96:1	108:1

3.6 Product identification

The following information is required to identify the RollerDrive:

Information	Possible value	Own value
RollerDrive	Motor type	
Rating plate	Gear ratio Serial number Mechanical power Supply voltage Analogue/CAN bus	
Tube diameter	50 mm, 60 mm	
Tube material	Stainless steel Zinc-plated steel Chromium-plated steel Aluminium	
Tube sleeve	PVC hose 2 mm, 5 mm PU hose 2 mm Rubber coating 2–5 mm Tapered elements 1.8°, 2.2°	
Installation length RollerDrive	Installation length	
Drive element on the non-cable side	PolyVee drive head Round belt: Two grooves Round belt head Toothed belt drive head Sprocket drive head	
Attachment on the non-cable side	Hexagonal spring shaft Internal thread attachment Hexagonal spring shaft, conical (See „Dimensions of the bearing housings on the non-cable side“ on page 36)	

Product information

3.7 Technical specifications

EC5000 20 W – AI/BI – 24 V DC

Rated voltage	24 V DC, protected extra-low voltage (PELV)
Voltage range	18 to 28 V DC
Rated current	1.2 A/1.4 A ¹⁾
Starting current	3.0 A ²⁾
Switching threshold, signal input "Rotational direction"	Safe "High": U > 7 V DC Safe "Low": U < 4 V DC
Maximum residual ripple of the power supply	3%
Maximum noise level (mounted)	55 dB(A) ³⁾
Protection rate	IP54 or IP66
UL type rating	Type rating 2 (optional)
Ambient temperature in operation	0 °C to +40 °C
Ambient temperature for transport and storage	-30 °C to +75 °C
Altitude of installation site	Max. 1000 m ⁴⁾

All data applies for an ambient temperature of 20 °C.

From 25 °C, a derating factor must be taken into account.

¹⁾ Higher rated current at gear ratios of 78:1 and 108:1 (three-stage rather than two-stage gear)

²⁾ The actual current course is dependent on the circumstances of the application, such as conveyor weight, number of connected rollers, etc.

³⁾ The value can vary depending on the installation condition, profile shapes and system resonance behaviour.

⁴⁾ Estimated derating: 5% from 1500 m, 10% from 2000 m.

EC5000 35 W – AI/BI – 24 V DC

Rated voltage	24 V DC, protected extra-low voltage (PELV)
Voltage range	18 to 28 V DC
Rated current	2.2 A/2.4 A ¹⁾
Starting current	5.5 A ²⁾
Switching threshold, signal input "Rotational direction"	Safe "High": U > 7 V DC Safe "Low": U < 4 V DC
Maximum residual ripple of the power supply	3%
Maximum noise level (mounted)	55 dB(A) ³⁾
Protection rate	IP54 or IP66 ⁴⁾
UL type rating	Type rating 2 (optional)
Ambient temperature in operation	0 °C to +40 °C (30:1, 42:1, 49:1 = -30 °C to +40 °C)
Ambient temperature for transport and storage	-30 °C to +75 °C
Altitude of installation site	Max. 1000 m ⁵⁾

All data applies for an ambient temperature of 20 °C.

From 25 °C, a derating factor must be taken into account.

¹⁾ Higher rated current at gear ratios of 78:1 and 108:1 (three-stage rather than two-stage gear)

²⁾ The actual current course is dependent on the circumstances of the application, such as conveyor weight, number of connected rollers, etc.

³⁾ The value can vary depending on the installation condition, profile shapes and system resonance behaviour.

⁴⁾ IP66 not for Deep Freeze applications

⁵⁾ Estimated derating: 5% from 1500 m, 10% from 2000 m.

Product information

EC5000 50 W – AI/BI – 24 V DC

Rated voltage	24 V DC, protected extra-low voltage (PELV)
Voltage range	18 to 28 V DC
Rated current	3.0 A/3.4 A ¹⁾
Starting current	7.5 A ²⁾
Switching threshold, signal input "Rotational direction"	Safe "High": U > 7 V DC Safe "Low": U < 4 V DC
Maximum residual ripple of the power supply	3%
Maximum noise level (mounted)	55 dB(A) ³⁾
Protection rate	IP54 or IP66 ⁴⁾
UL type rating	Type rating 2 (optional)
Ambient temperature in operation	-30 °C to +40 °C
Ambient temperature for transport and storage	-30 °C to +75 °C
Altitude of installation site	Max. 1000 m ⁵⁾

All data applies for an ambient temperature of 20 °C.

From 25 °C, a derating factor must be taken into account.

- ¹⁾ Higher rated current at gear ratios of 78:1 and 108:1 (three-stage rather than two-stage gear)
- ²⁾ The actual current course is dependent on the circumstances of the application, such as conveyor weight, number of connected rollers, etc.
- ³⁾ The value can vary depending on the installation condition, profile shapes and system resonance behaviour.
- ⁴⁾ IP66 not for Deep Freeze applications
- ⁵⁾ Estimated derating: 5% from 1500 m, 10% from 2000 m.

EC5000 20 W – AI/BI – 48 V DC

Rated voltage	48 V DC, protected extra-low voltage (PELV)
Voltage range	36 to 56 V DC
Rated current	0.6 A/0.7 A ¹⁾
Starting current	1.5 A ²⁾
Switching threshold, signal input "Rotational direction"	Safe "High": U > 7 V DC Safe "Low": U < 4 V DC
Maximum residual ripple of the power supply	3%
Maximum noise level (mounted)	55 dB(A) ³⁾
Protection rate	IP54 or IP66
UL type rating	Type rating 2 (optional)
Ambient temperature in operation	0 °C to +40 °C
Ambient temperature for transport and storage	-30 °C to +75 °C
Altitude of installation site	Max. 1000 m ⁴⁾

All data applies for an ambient temperature of 20 °C.

From 25 °C, a derating factor must be taken into account.

¹⁾ Higher rated current at gear ratios of 78:1 and 108:1 (three-stage rather than two-stage gear)

²⁾ The actual current course is dependent on the circumstances of the application, such as conveyor weight, number of connected rollers, etc.

³⁾ The value can vary depending on the installation condition, profile shapes and system resonance behaviour.

⁴⁾ Estimated derating: 5% from 1500 m, 10% from 2000 m.

Product information

EC5000 35 W – AI/BI – 48 V DC

Rated voltage	48 V DC, protected extra-low voltage (PELV)
Voltage range	36 to 56 V DC
Rated current	1.1 A/1.2 A ¹⁾
Starting current	2.8 A ²⁾
Switching threshold, signal input "Rotational direction"	Safe "High": U > 7 V DC Safe "Low": U < 4 V DC
Maximum residual ripple of the power supply	3%
Maximum noise level (mounted)	55 dB(A) ³⁾
Protection rate	IP54 or IP66 ⁴⁾
UL type rating	Type rating 2 (optional)
Ambient temperature in operation	0 °C to +40 °C (30:1, 42:1, 49:1 = -30 °C to +40 °C)
Ambient temperature for transport and storage	-30 °C to +75 °C
Altitude of installation site	Max. 1000 m ⁵⁾

All data applies for an ambient temperature of 20 °C.

From 25 °C, a derating factor must be taken into account.

- ¹⁾ Higher rated current at gear ratios of 78:1 and 108:1 (three-stage rather than two-stage gear)
- ²⁾ The actual current course is dependent on the circumstances of the application, such as conveyor weight, number of connected rollers, etc.
- ³⁾ The value can vary depending on the installation condition, profile shapes and system resonance behaviour.
- ⁴⁾ IP66 not for Deep Freeze applications
- ⁵⁾ Estimated derating: 5% from 1500 m, 10% from 2000 m.

EC5000 50 W – AI/BI – 48 V DC

Rated voltage	48 V DC, protected extra-low voltage (PELV)
Voltage range	36 to 56 V DC
Rated current	1.5 A/1.7 A ¹⁾
Starting current	3.8 A ²⁾
Switching threshold, signal input "Rotational direction"	Safe "High": U > 7 V DC Safe "Low": U < 4 V DC
Maximum residual ripple of the power supply	3%
Maximum noise level (mounted)	55 dB(A) ³⁾
Protection rate	IP54 or IP66 ⁴⁾
UL type rating	Type rating 2 (optional)
Ambient temperature in operation	-30 °C to +40 °C
Ambient temperature for transport and storage	-30 °C to +75 °C
Altitude of installation site	Max. 1000 m ⁵⁾

All data applies for an ambient temperature of 20 °C.

From 25 °C, a derating factor must be taken into account.

¹⁾ Higher rated current at gear ratios of 78:1 and 108:1 (three-stage rather than two-stage gear)

²⁾ The actual current course is dependent on the circumstances of the application, such as conveyor weight, number of connected rollers, etc.

³⁾ The value can vary depending on the installation condition, profile shapes and system resonance behaviour.

⁴⁾ IP66 not for Deep Freeze applications

⁵⁾ Estimated derating: 5% from 1500 m, 10% from 2000 m.

Product information

3.8 Performance data

EC5000 20 W – 24 V DC/48 V DC

Gear ratio	Conveyor speed 50mm roller [m/s]		Rated torque [Nm]	Acceleration torque [Nm]	Continuous blocking torque [Nm]	Breakaway torque [Nm]
	Max.	Min.				
9:1	2,01	0,09	0,25	0,63	0,63	1,01
13:1	1,39	0,06	0,36	0,91	0,91	1,46
18:1	1,00	0,04	0,50	1,26	1,26	2,02
21:1	0,86	0,04	0,59	1,47	1,47	2,36
30:1	0,60	0,03	0,85	2,13	2,13	3,40
42:1	0,43	0,02	1,18	2,95	2,95	4,71
49:1	0,37	0,02	1,37	3,44	3,44	5,50
78:1	0,23	0,01	2,02	5,43	5,43	8,68
108:1	0,17	0,01	2,82	7,57	7,57	12,12

All data applies for an ambient temperature of 20 °C.

Before the run-in, the values can vary by up to $\pm 20\%$. After the run-in phase, the values for 95% of all RollerDrives used vary only in the range of $\pm 10\%$.

Rated torque

Torque that the RollerDrive can deliver at an ambient temperature of 20 °C and at the rated speed during continuous operation.

Acceleration torque

Torque available to the RollerDrive during operation to counteract a load.

Acceleration torque = rated torque x 2.5.

The acceleration torque cannot be greater than 13 Nm.

Continuous blocking torque (Zero Motion Hold)

Continuous blocking torque = Acceleration torque.

EC5000 35 W – 24 V DC/48 V DC

Gear ratio	Conveyor speed 50mm roller [m/s]		Rated torque [Nm]	Acceleration torque [Nm]	Continuous blocking torque [Nm]	Breakaway torque [Nm]
	Max.	Min.				
9:1	2,01	0,09	0,44	1,11	1,11	1,77
13:1	1,39	0,06	0,64	1,60	1,60	2,56
18:1	1,00	0,04	0,89	2,22	2,22	3,55
21:1	0,86	0,04	1,04	2,59	2,59	4,14
30:1	0,60	0,03	1,49	3,74	3,74	5,98
42:1	0,43	0,02	2,07	5,18	5,18	8,28
49:1	0,37	0,02	2,42	6,04	6,04	9,66
78:1	0,23	0,01	3,55	9,54	9,54	13,00
108:1	0,17	0,01	4,95	13,00	13,00	13,00

All data applies for an ambient temperature of 20 °C.

Before the run-in, the values can vary by up to $\pm 20\%$. After the run-in phase, the values for 95% of all RollerDrives used vary only in the range of $\pm 10\%$.

Breakaway torque

The breakaway torque is available at a motor speed of < 350 rpm and a motor temperature of < 70 °C.

The breakaway torque is available in the frequency $1 \text{ s} - 4 \times M_{\text{Rated}}/2 \text{ s} - 2.5 \times M_{\text{Rated}}$.

The breakaway torque cannot be greater than 13 Nm.

Product information

EC5000 50 W – 24 V DC/48 V DC

Gear ratio	Conveyor speed 50mm roller [m/s]		Rated torque [Nm]	Acceleration torque [Nm]	Continuous blocking torque [Nm]	Breakaway torque [Nm]
	Max.	Min.				
9:1	2,01	0,09	0.63	1.58	1.58	2.54
13:1	1,39	0,06	0.91	2.29	2.29	3.66
18:1	1,00	0,04	1.27	3.17	3.17	5.07
21:1	0,86	0,04	1.48	3.70	3.70	5.92
30:1	0,60	0,03	2.13	5.34	5.34	8.54
42:1	0,43	0,02	2.96	7.40	7.40	11.83
49:1	0,37	0,02	3.45	8.63	8.63	13.00
78:1	0,23	0,01	5.07	13.00	13.00	13.00
108:1	0,17	0,01	7.07	13.00	13.00	13.00

All data applies for an ambient temperature of 20 °C.

Before the run-in, the values can vary by up to $\pm 20\%$. After the run-in phase, the values for 95% of all RollerDrives used vary only in the range of $\pm 10\%$.

3.9 Control systems for the RollerDrive EC5000

Interroll recommends that the RollerDrive EC5000 is operated in conjunction with the different Interroll control systems:

Control system	Analogue interface						Bus interface					
	24 V			48 V			24 V			48 V		
	20 W	35 W	50 W	20 W	35 W	50 W	20 W	35 W	50 W	20 W	35 W	50 W
DriveControl 20/DriveControl 54	X	X										
DriveControl 2048	X	X	X	X	X	X						
ZoneControl	X	X										
ConveyorControl	X	X										
MultiControl AI	X	X	X	X	X	X						
MultiControl BI							X	X	X	X	X	X



More detailed information on the control systems can be found in the respective operating manual, in the "Conveyor rollers, RollerDrive, control systems" Interroll catalogue or at www.interroll.com.

Product information

3.10 RollerDrive connector AI

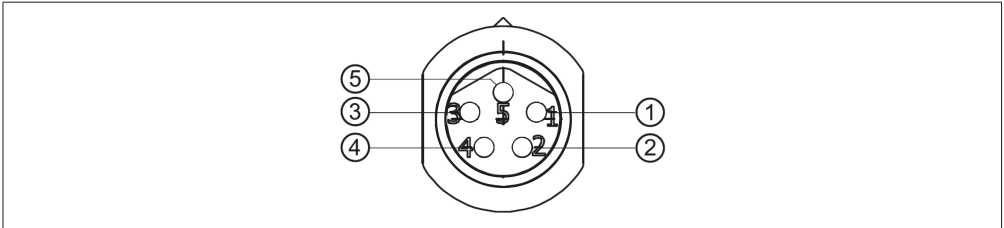

Pin	Colour	Function	Value
1	Brown	Input of the power supply (+)	Rated voltage: 24 V DC 48 V DC Voltage range: 18 to 28 V DC 36 to 56 V DC
2	White	Input of the rotational direction as seen from the end of the cable of the RollerDrive	"Low" = anti-clockwise "High" = clockwise
3	Blue	Earth for power supply and signal (-)	Earth
4	Black	Error output	Open collector $U_{CESAT} = 0.5 \text{ V DC at } I_C = 5 \text{ mA}$ $U_{MAX} = 30 \text{ V DC}$ $I_{CMAX} = 5 \text{ mA}$ Error: "High" signal No error: "Low" signal
5	Grey	Analogue speed/start signal	See table "Analogue speed/start signal (pin 5)"

NOTE

Incorrect connected loads can destroy the RollerDrive.

- Do not attempt to operate a RollerDrive EC5000 24 V DC at 48 V DC. This will destroy the motor electronics.
- Check the colour ring on the motor connector before connecting (see „Colour rings on the connectors“ on page 15).

Analogue speed/start signal (pin 5)

Voltage range	0 to 24 V DC
Stop (zero motion hold)	0 to 2.3 V DC
Speed	2.3 V DC to 10 V DC 2.3 V = Minimum speed = 300 rpm 10 V = Maximum speed = 6900 rpm
Max. speed	10 V DC to 24 V DC



The conveyor speed results from the gear ratio and the voltage rating of the analogue speed signal.

3.11 RollerDrive connector BI

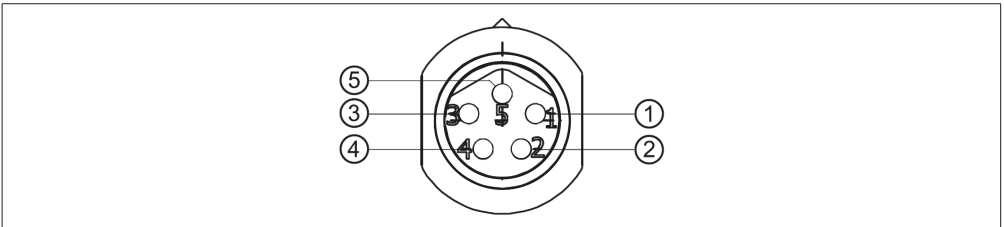

Pin	Colour	Function	Value		
1	Brown	Input of the power supply (+)	Rated voltage:	24 V DC	48 V DC
			Voltage range:	18 to 28 V DC	36 to 56 V DC
2	White	CAN High			
3	Blue	Earth for power supply and signal (-)	Earth		
4	Black	CAN Low			
5	Grey	Service manufacturer			

NOTE

Connecting/disconnecting under voltage can destroy the RollerDrive EC5000 with bus interface

- The RollerDrive EC5000 BI is not hot-plug-compatible. Disconnect the power supply to connect/disconnect the RollerDrive EC5000 BI.

Product information

3.12 Dimensions of the motor shaft

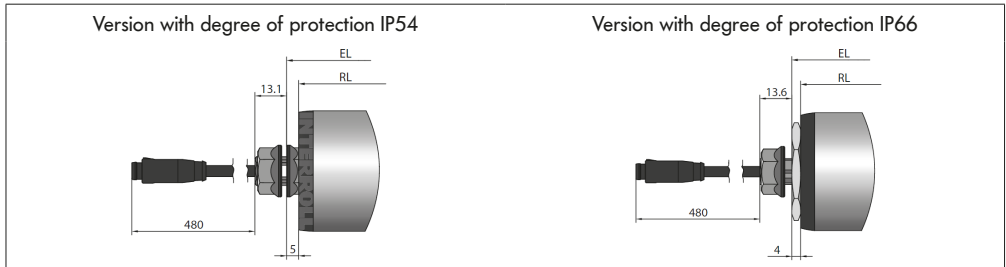

RL = Reference length/order length

EL = Installation length, clearance between the side profiles

3.13 Dimensions of the bearing housings on the non-cable side

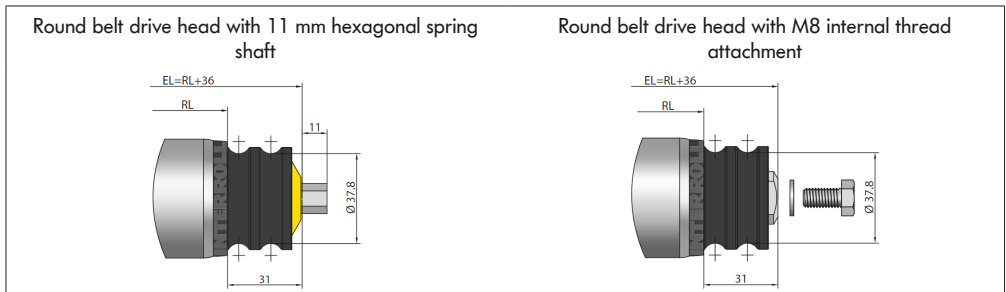
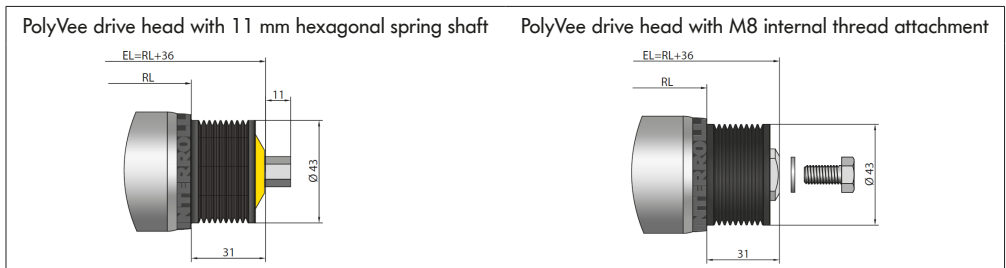

2 grooves and conical hexagonal spring shaft

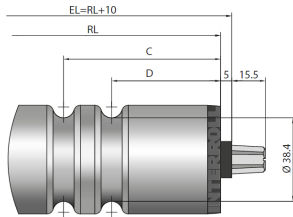

2 grooves and M8 internal thread attachment

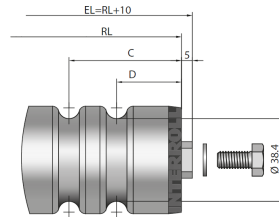

Toothed belt drive head with M8 internal thread attachment

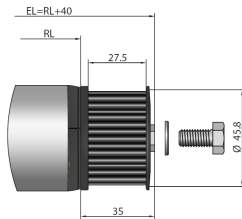

Hexagonal spring shaft, conical

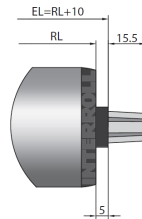

M8 internal thread attachment

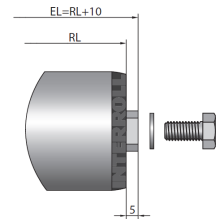

Sprocket drive head with M8 internal thread attachment

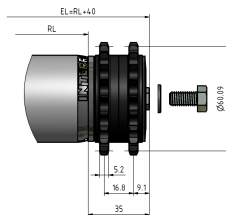

Product information

EC5000 IP66

2 grooves and M8 internal thread attachment

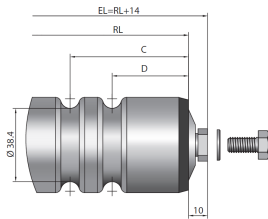

M8 internal thread attachment

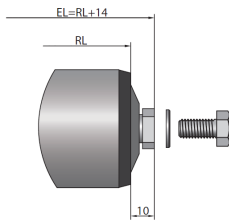

PolyVee drive head with M8 internal thread attachment

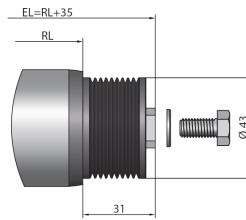

4 Transport and storage

4.1 Transport



CAUTION

Risk of injury from improper transport.

- Transport operations must only be carried out by authorised, qualified personnel.
-

Please note the following:

- Avoid heavy impacts during transport.
- Check each RollerDrive after transport for any visible damage.
- If any damage has been identified, photograph the damaged parts.
- In the event that damage has been incurred during transport, inform the shipping agent or Interroll immediately to ensure that you do not lose any potential damage claims.
- Do not expose the RollerDrive to any strong fluctuations in temperature, since this can lead to condensation forming.

4.2 Storage



CAUTION

Risk of injury due to improper storage.

- Ensure that the RollerDrive is stored safely.
-

Please note the following:

- Do not stack pallets on top of one another.
- Check each RollerDrive after storage for any visible damage.

Assembly and installation

5 Assembly and installation

5.1 Warning notices for installation



WARNING

Risk of electric shock!

When using the RollerDrive EC5000 48 V DC, it is possible that in generator operation (motor revolution 14.500 min⁻¹ / gear reduction) the permissible contact voltage of 60 V DC at the open connector is exceeded.

- Do not drive unconnected RollerDrive from the outside.



For the RollerDrive EC5000 24 V DC, exceeding the permissible contact voltage is only theoretically possible.



CAUTION

Risk of crushing due to rotating parts.

- Do not place your fingers between the RollerDrive and the round belt/PolyVee belt.
- Install protective equipment (e.g. Interroll PolyVee finger guard) to prevent fingers from getting caught in the PolyVee belt or round belt.
- Affix suitable warning notices/pictograms to the conveyor.

NOTE

An improper approach to installing the RollerDrive can lead to material damage or reduce the service life of the RollerDrive.

- To preserve the interior of the RollerDrive, do not allow the RollerDrive to fall or for it to be used in an improper fashion.
- Check each RollerDrive before assembly for any visible damage.
- To prevent the inner connections from being damaged, do not hold, carry or secure the RollerDrive by the cable.
- Do not use force to insert the RollerDrive into the side profile. It must be inserted gently into the side profile.
- Pay attention to the correct tightening torque of the RollerDrive hexagonal nut to prevent the shaft in the side profile from rotating and the RollerDrive cable from twisting (see „Securing the RollerDrive in the side profile“ on page 43).
- Do not twist the RollerDrive cable.

5.2 Installing the RollerDrive

Installing the attachment shaft

NOTE

Internal parts of the RollerDrive can be damaged through improper handling.

- Do not fit the fastening nut yet
- Do not bend the RollerDrive cable. Allow at least 12 mm of cable to offset tensile or pressure loads.
- Ensure correct equipotential bonding of all metallic elements of the conveyor unit (RollerDrive, side profile, supporting structure, etc.). Improper earthing can lead to a build-up of static charge, which can result in a malfunction or premature failure of the RollerDrive and/or the connected control system.

- Remove packaging material and transport protection from the RollerDrive.



To guarantee safe equipotential bonding of the RollerDrive, the fastening nut must be in direct contact with the metallic surface of the earthed side profile.

- If necessary, remove the coating of the side profile in the area of the fastening nut.
- Insert the RollerDrive cable and attachment shaft into the hex hole provided (min. 11.2 mm) or round hole (min. 12.2 mm) of the side profile.

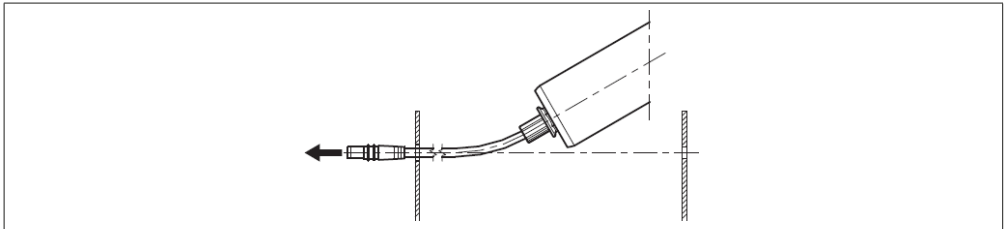

- Position one or two round belts of 4 mm (max. 5 mm) or PolyVee belts.

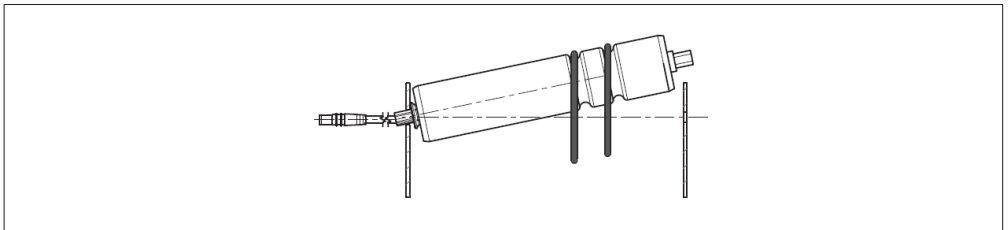

Assembly and installation

Attaching the non-cable side

Two examples are provided:

Inserting the hexagonal spring shaft

- Press the spring shaft inwards and align the shaft so that it corresponds to the opening in the side profile.

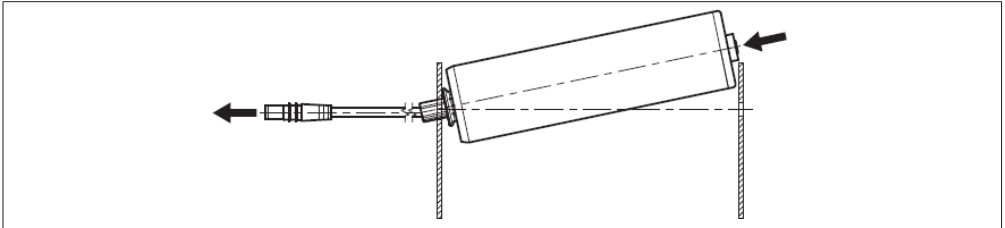

- Release the hexagonal spring shaft so that it springs into the opening of the side profile.

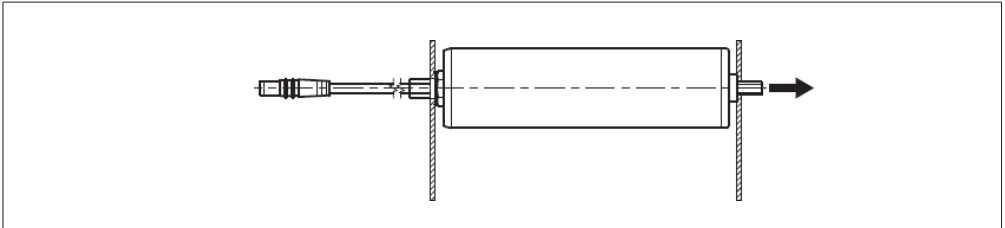

Inserting the internal thread shaft pin

- Place a washer on a M8x20 screw.
- Align the RollerDrive with the opening in the side profile and insert the M8 screw with the washer into the opening. Secure the shaft pin with an open-ended spanner to prevent it from twisting (depending on the version of the shaft pin, the width across flats will be 13 mm or 19 mm).

Assembly and installation

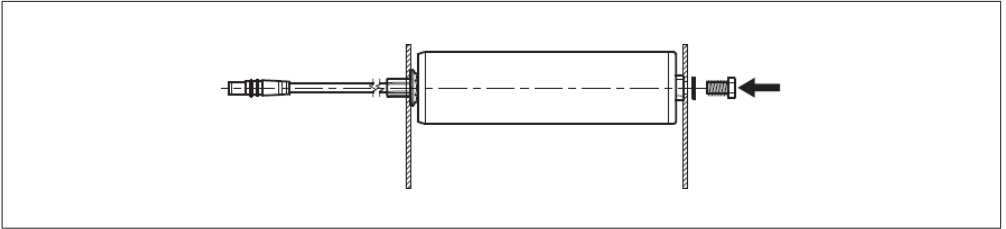

- Tighten the screw using a torque spanner with a tightening torque of 20 Nm.



If the parts used for attaching the RollerDrive are not the parts that have been supplied by Interroll, it is important to ensure that the attachment is secure enough that it will not twist.

Securing the RollerDrive in the side profile

A nut is located close to the bearing housing on the attachment shaft. This inner nut is pre-fitted and secured in the correct position.



Do not twist the inner nut.

- Secure the inner nut with a flattened counter ratchet with a 17 mm width across flats (accessory) to prevent it from twisting.
- Slide the nut included in the scope of delivery over the RollerDrive line and screw it onto the attachment shaft.

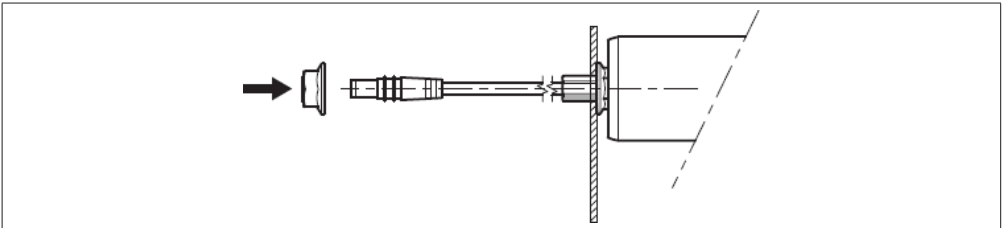

- Tighten the nut using a torque spanner with a tightening torque of 70 Nm.



For installing a RollerDrive with tapered elements, the attachment shaft is positioned at an angle of 1.8° or 2.2° to the side profile. To prevent bending forces from acting on the attachment shaft, an appropriate angle compensator must be provided for the attachment. This is not included in the scope of delivery.

Assembly and installation

The Interroll Interlock (optional)

To permanently prevent the RollerDrive from twisting in the side profile, Interroll has developed the Interlock.

Instead of the nut included in the scope of delivery, the Interlock is slid over the RollerDrive cable and attached to the conveyor frame using the corresponding screw.

The self-tapping screw provided eliminates the need for pre-drilling.

Alternatively, the Interlock can also be attached using an M5 threaded bolt.

Screwing it into the side profile pulls together the sides of the Interlock, which secures the RollerDrive to the conveyor frame and prevents it from twisting.

- Remove the finger guard from the self-tapping screw of the Interlock.
- Slide the Interroll Interlock over the RollerDrive cable and place it on the attachment shaft.
- Screw the self-tapping screw into the side profile of the conveyor frame, ideally using a cordless screwdriver and hexagonal spanner head (WAF 8).
- Pull the finger guard on the inside of the side profile onto the self-tapping screw.

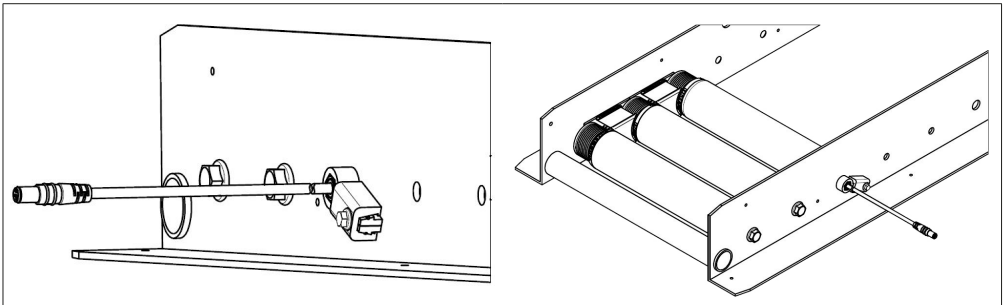

CAUTION

Risk of injury if the finger guard is not in place.

- Pull the finger guard on the inside of the side profile onto the self-tapping screw.

NOTE

Possible damage to the RollerDrive caused by the self-tapping screw.

With a roller diameter of > 60 mm, the self-tapping screw can block the RollerDrive.

- Note the length of the self-tapping screw in the case of larger roller diameters.
- Alternatively, use shorter threaded bolts.

5.3 Installation tool (accessory)



For the installation of the PolyVee belt, we recommend using the PolyVee clamping aid, which is available as an accessory.

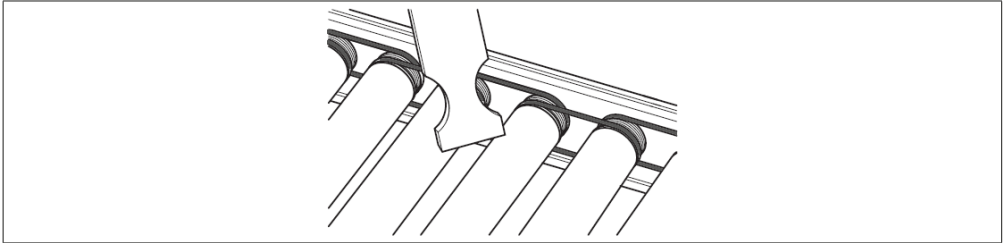

- Attach the first roller.
- Position the PolyVee clamping aid between the attached roller and the roller/RollerDrive that has not yet been attached.
- Rotate the PolyVee clamping aid by 90° so that the rollers are positioned in the cut-outs intended for them.
- The belt is optimally tensioned and a roller/RollerDrive is properly aligned horizontally and vertically. An internal thread attachment is consequently aligned with the attachment hole in the side profile.

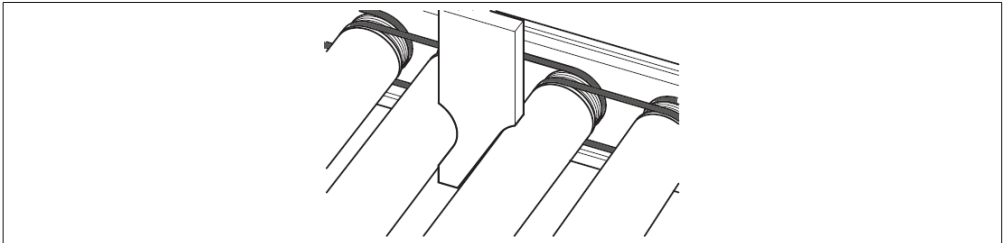

The PolyVee clamping aid is intended for the 75 mm and 100 mm roller pitches and designed for rollers and RollerDrives with a diameter of 50 mm.

Assembly and installation

5.4 Warning notices for electrical installation



WARNING

Risk of crushing from uncontrolled start-up of the RollerDrive.

- Before connecting the RollerDrive, switch off the power to the conveyor system and ensure that it cannot be unintentionally switched on again.
-

5.5 Electrical installation

NOTE

Risk of material damage to the RollerDrive and/or the RollerDrive cables.

- Never operate the RollerDrive with an alternating current (AC), as this can result in irreparable damage to the device.
 - Do not expose the RollerDrive connector to excessively high tensile or pressure loads. Bending the RollerDrive cables or sliding the attachment nut on too forcefully can damage the insulation of the cables, which can lead to the failure of the RollerDrive.
 - Do not bend the RollerDrive cable at the attachment shaft. Allow at least 12 mm of cable to offset tensile or pressure loads.
 - Permissible bending radii: Simple bending 25 mm, multiple bending 50 mm.
-
- Connect the RollerDrive connector to the corresponding connection of the Interroll control system.
-  If no Interroll control system is used, an adapter cable must be used to connect the RollerDrive to the control system (for pin assignment, see „RollerDrive connector AI“ on page 34). Cutting off the RollerDrive connector will void the warranty.
- When using an extension cable to connect the RollerDrive, a max. length of 10 m must not be exceeded.

6 Start-up and operation

6.1 Warning notices for start-up and operation



WARNING

Risk of crushing and potential hazards from rotating parts due to uncontrolled start-up of the RollerDrive.

- Do not reach between RollerDrive and drive media with your fingers.
- Do not remove the protective equipment.
- Keep fingers, hair and loose clothing away from the RollerDrive.

NOTE

Possible damage to the RollerDrive through induction.

- Do not slide any objects over the roller conveyor by hand.
- Do not turn the RollerDrive by hand.

6.2 Start-up

Check before the initial start-up

- Ensure that there are no points of contact between objects and rotating/moving parts.
- Ensure that all screws have been tightened according to the specifications.
- Ensure that no additional hazards are formed through the interfaces to other components.
- Ensure that the wiring conforms to specifications and legal provisions.
- Ensure that no persons are in the hazardous areas by the conveyor system.
- Check all protective equipment.



Information on start-up can be found in the operating manual for the Interroll control system or motor control system that is used.

Start-up and operation

6.3 Operation

Check before every start-up

- Ensure that no persons are in the hazardous areas by the conveyor system.
- Ensure that the RollerDrive is not jammed.
- Check the RollerDrive for any visible damage.
- Check all protective equipment.
- Specify in detail how the material to be conveyed should be set down on the conveyor and monitor this to ensure it is carried out correctly.



Take the ambient conditions into account during operation (see „Technical specifications“ on page 24).

6.4 Procedure in the event of accidents or faults

- Stop the conveyor system immediately, switch off the power supply and ensure that it cannot be unintentionally switched on again.
- In the event of an accident: Perform first aid and call for the emergency services.
- Inform the relevant supervisor.
- Have specialist personnel rectify the fault.
- Only resume operating the conveyor system once this has been approved by the specialist personnel.

7 Maintenance and cleaning



WARNING

Risk of injury from following incorrect procedure.

- Maintenance and repair work must only be carried out by authorised and trained (specialist) personnel.
 - Maintenance and repair work must only be carried out when the system has been disconnected from the power supply. Switch off the power to the RollerDrive and ensure that it cannot be unintentionally switched on again.
 - Put up signs to indicate that maintenance or cleaning work is being carried out.
-

7.1 Maintenance

Checking the RollerDrive

If the RollerDrive is not secured according to the installation instructions (see „Installing the RollerDrive“ on page 41), it may rotate in the side profile. This means that the RollerDrive cable may twist and become damaged.

- One month after the RollerDrive has been installed, check to ensure it is still firmly seated in the side profile and tighten it with a torque spanner if necessary.
- Check the RollerDrive every month for any visible damage.
- Once a year, ensure that the shaft of the RollerDrive is still correctly secured in the side profile.

Replacing the RollerDrive

If a RollerDrive is damaged or defective, it must be replaced.



Do not attempt to open the RollerDrive.

- Install a new RollerDrive (see „Decommissioning“ on page 52 and „Installing the RollerDrive“ on page 41).

Maintenance and cleaning

7.2 Cleaning

- Remove any foreign bodies and coarse impurities from the surface of the roller.
- Minor impurities can be removed using a damp cloth.
- Do not use any sharp-edged tools to clean the RollerDrive.

8 Assistance in the event of faults



WARNING

Risk of injury from following incorrect procedure.

- Troubleshooting must only be carried out by authorised, qualified personnel.
- Troubleshooting must only be carried out when the system has been disconnected from the power supply.
- Switch off the power to the RollerDrive and ensure that it cannot be unintentionally switched on again.

8.1 Troubleshooting

Fault	Possible cause	Remedy
RollerDrive does not run.	No / wrong supply voltage.	Check the 24 V DC / 48 V DC power supply.
	RollerDrive connector is not connected correctly.	Check the cable connection.
	Wrong interface selection AI / BI	Connect correct RollerDrive
RollerDrive turns in the wrong direction or at the wrong speed.	Settings for speed and rotational direction are incorrect.	Change the settings for the Interroll control system.
	Incorrect voltage set point for rotational speed, should the RollerDrive not be operated with an Interroll control system.	Check the voltage set point.
Unusual noises can be heard from the RollerDrive.	Motor or gears are damaged.	Replace the RollerDrive.
Operation of the RollerDrive is interrupted.	RollerDrive cable is damaged.	Check the RollerDrive cable for damage. If the cable is defective, replace the RollerDrive.
	RollerDrive is overloaded.	See „Overload protection“ on page 16.

Decommissioning and disposal

9 Decommissioning and disposal



CAUTION

Risk of injury from following incorrect procedure.

- Decommissioning must only be carried out by authorised, qualified personnel.
- Only decommission the RollerDrive when the system has been disconnected from the power supply.
- Switch off the power to the RollerDrive and ensure that it cannot be unintentionally switched on again.

9.1 Decommissioning

- Disconnect the RollerDrive cable from the control system.
- Remove the outer nut from the motor shaft.
- Remove Interroll Interlock.
- If the RollerDrive is fitted with an internal thread shaft pin, remove the screw on the shaft.
- Remove the RollerDrive from the side profile.

9.2 Disposal



The operating company is responsible for disposing of the RollerDrive according to correct procedure. In doing so, the industry-specific and local provisions for disposing of the RollerDrive and its packaging must be observed.

10 Appendix

10.1 Accessories

Interroll control systems

Article	Article number	
DriveControl 20	S-1001415	
DriveControl 54	S-1001416	
DriveControl 2048	S-1113898	
ZoneControl	S-1004023	
ConveyorControl	GatewayControl PROFIBUS	S-1004026
	GatewayControl PROFINET	S-1000275
	GatewayControl Ethernet/IP	S-1001732
	CentralControl	S-1004027
	SegmentControl	S-1004024
	ComControl	S-1004025
MultiControl AI	S-1103563	
MultiControl BI	S-1103564	

Interroll High Performance power supply unit

Article	Article number
HP5424	S-1113899
HP5448	S-1113900

RollerDrive extension cable

Article	Article number
Extension cable EC5000 (2 m)	S-1113897

Appendix

PolyVee belt

Number of ribs	Roller pitches +/-1 mm	Max. weight of material to be conveyed (kg)	Article number	Belt designation
2	60	50	S-1111211	256
2	75		S-1111217	286
2	90		S-1111220	314
2	100		S-1111222	336
2	120		S-1111224	376
3	60	300	S-1111216	256
3	75		S-1111219	286
3	90		S-1111221	314
3	100		S-1111223	336
3	120		S-1111225	376

PolyVee clamping aid

Article	Article number
PolyVee clamping aid	S-1101272

PolyVee finger guard

Article	Article number
Roller pitch 75 mm	S-8863
Roller pitch 100 mm	S-8864

Tool

Article	Article number
Attachment nut	S-1101248
Counter ratchet	S-1101270

10.2 Translation of the original Declaration of Conformity

EU Declaration of conformity

EMC Directive 2014/30/EU

RoHS Directive 2011/65/EU

The manufacturer

Interroll Engineering GmbH
Höferhof 16
42929 Wermelskirchen
Germany

hereby declares that the "incomplete machine"

- **RollerDrive EC5000**

conforms to the applicable provisions and the associated CE marking in accordance with the aforementioned Directives.

List of the coordinated standards that have been applied:
EN ISO 12100:2010
EN 61800-3:2004 + A1:2012

Declaration of incorporation

EC Machinery Directive 2006/42/EC

In addition to the information specified above, the manufacturer declares that:

The health and safety requirements have been applied in accordance with Annex I (1.1.2, 1.1.3, 1.1.5, 1.2.6, 1.3.7, 1.3.8, 1.5.1, 1.5.2, 1.5.4, 1.5.8, 1.5.9, 1.5.10, 1.5.11, 1.6.1, 1.6.3, 1.7.2, 1.7.3, 1.7.4). The relevant technical documentation has been compiled in accordance with Annex VII B and has been passed on to the relevant authorities where applicable.

The commissioning of the incomplete machine is prohibited until the conformity of the overall machine/system in which it is installed with the EC Machinery Directive has been declared.

Authorised for compiling technical documentation:
Interroll Engineering GmbH, Höferhof 16, 42929 Wermelskirchen, Germany

i.v. 

Jörg Schiffler
Product Compliance Officer Interroll Engineering GmbH
Wermelskirchen, 24.01.2019

INSPIRED BY EFFICIENCY

EN | 12/2019 | Version 2.2